

Detailheft Mär. 2013
LONGOTON®-Ziegelfassade

Detail book / Cahier technique



Moeding Keramikfassaden GmbH
Ludwig-Girnghuber-Straße 1
84163 Marklkofen
Germany

Telefon +49 (0) 87 32 / 246 00
Telefax +49 (0) 87 32 / 246 69

E-Mail: [info @moeding.de](mailto:info@moeding.de)
www.moeding.de

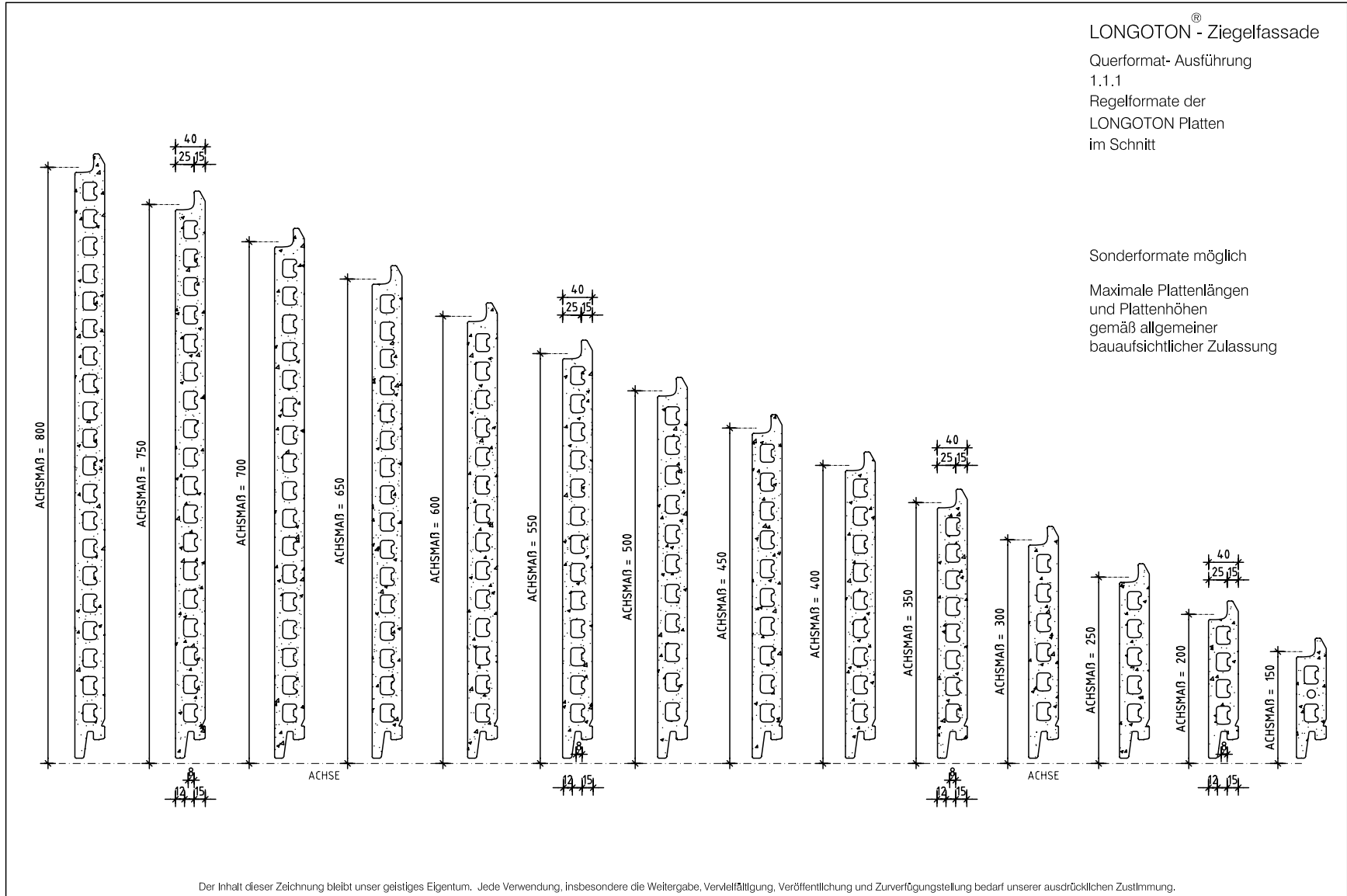

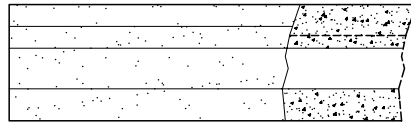

NORMALE PLATTE

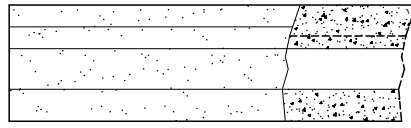
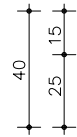
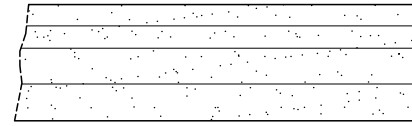

PLATTE MIT GEHRUNGSSCHNITT RECHTS

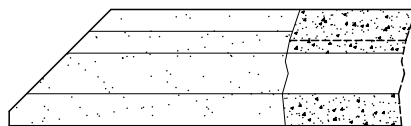
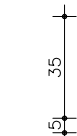
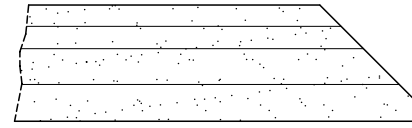

PLATTE MIT GEHRUNGSSCHNITT LINKS

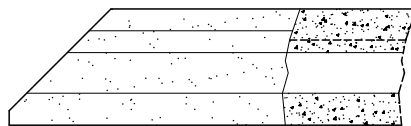
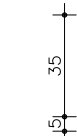
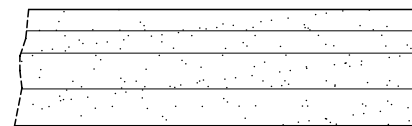
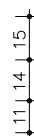

PLATTE MIT GEHRUNGSSCHNITT LINKS + RECHTS

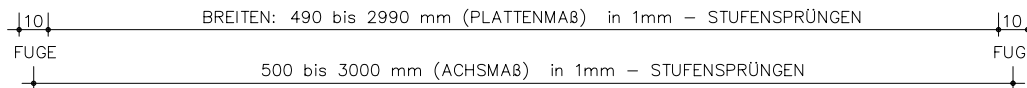
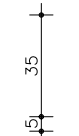
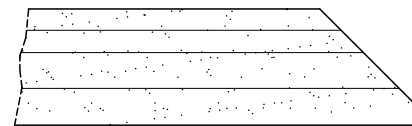
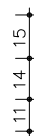

LONGOTON[®] - Ziegelfassade

Querformat- Ausführung
 1.1.2
 Regelformate der
 LONGOTON - Ziegelplatten
 in der Draufsicht

Maximale Plattenlängen
 und Plattenhöhen
 gemäß allgemeiner
 bauaufsichtlicher Zulassung

Der Inhalt dieser Zeichnung bleibt unser geistiges Eigentum. Jede Verwendung, insbesondere die Weitergabe, Vervielfältigung, Veröffentlichung und Zurverfügungstellung bedarf unserer ausdrücklichen Zustimmung.

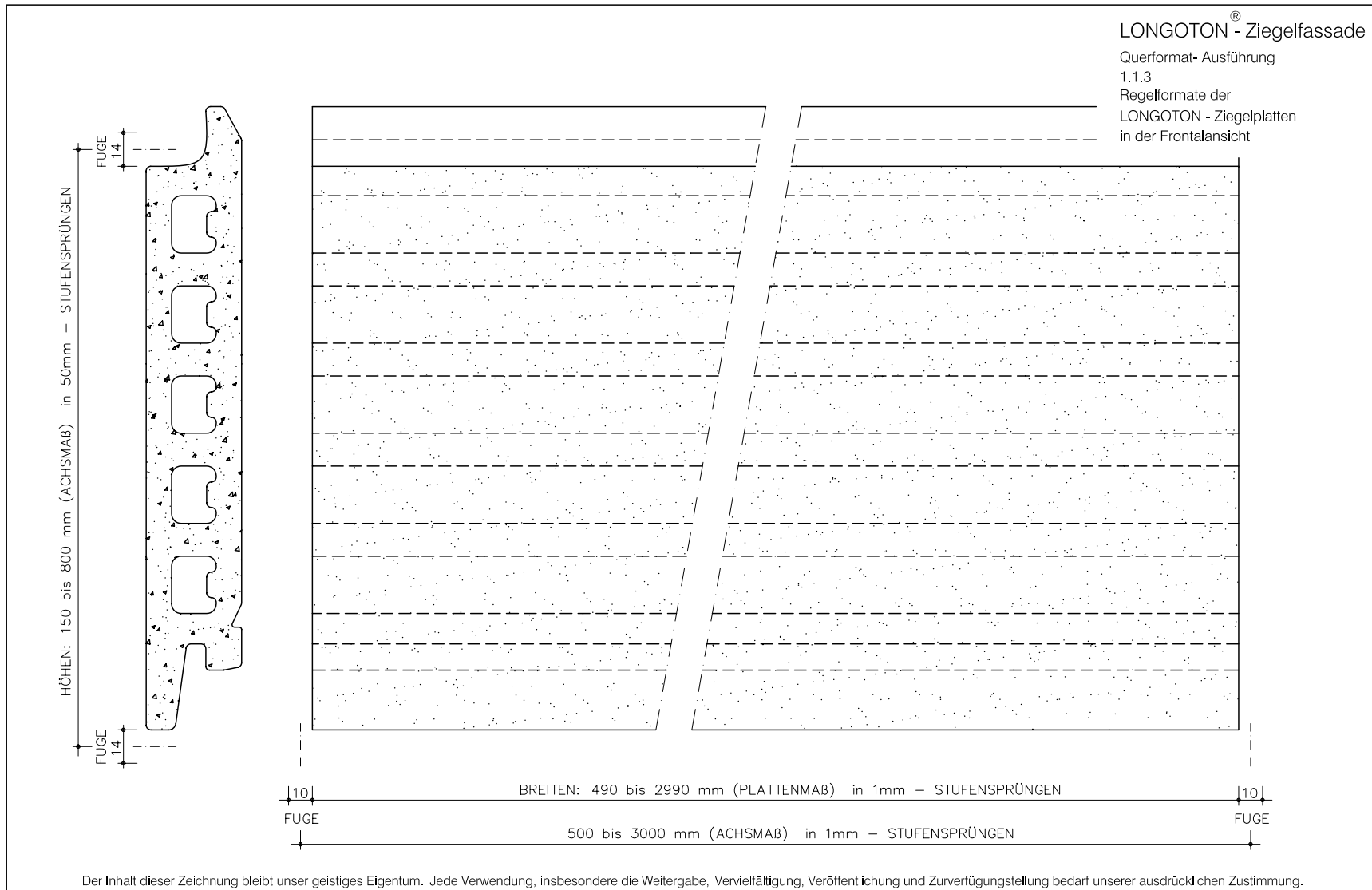

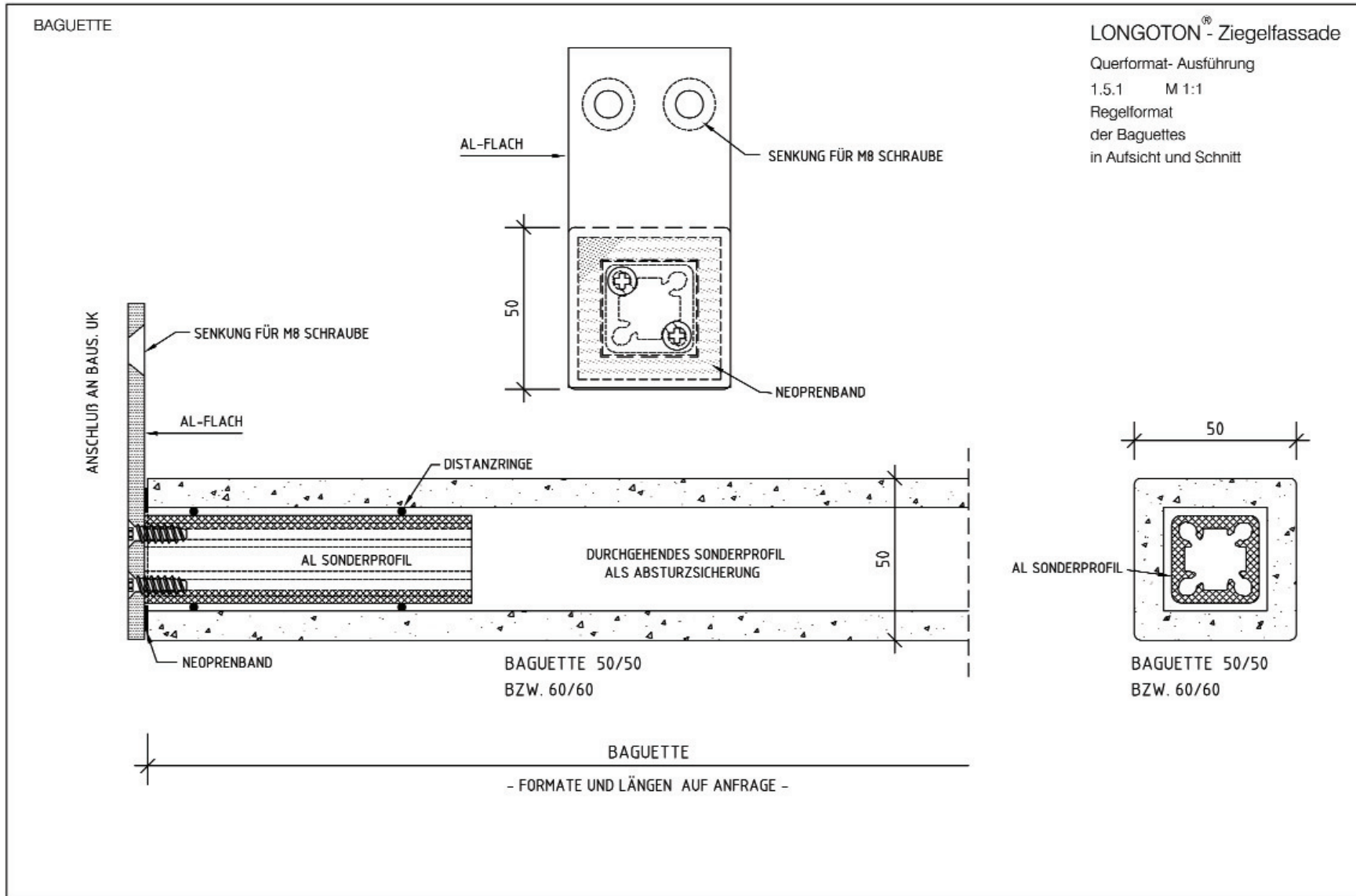

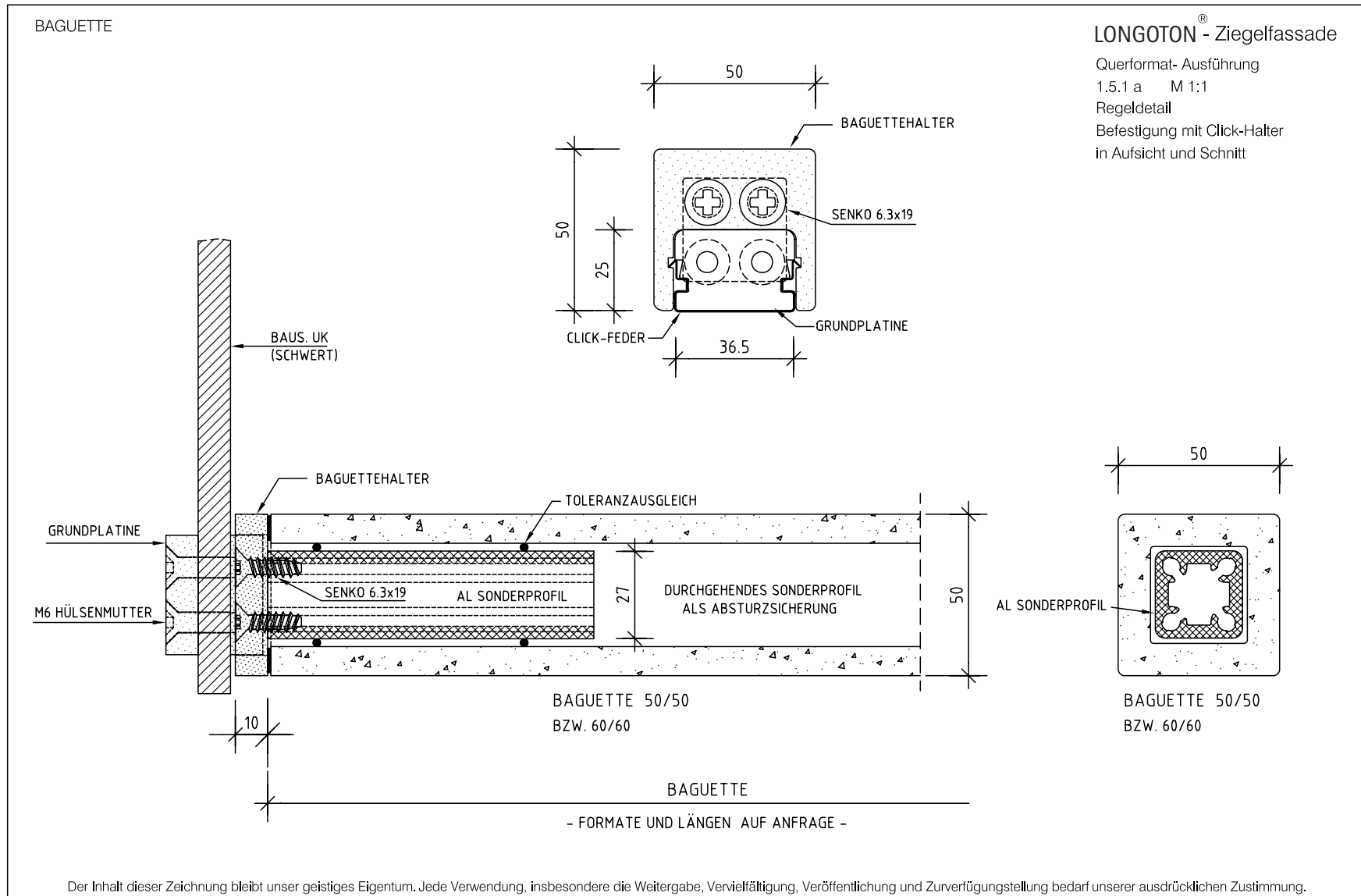

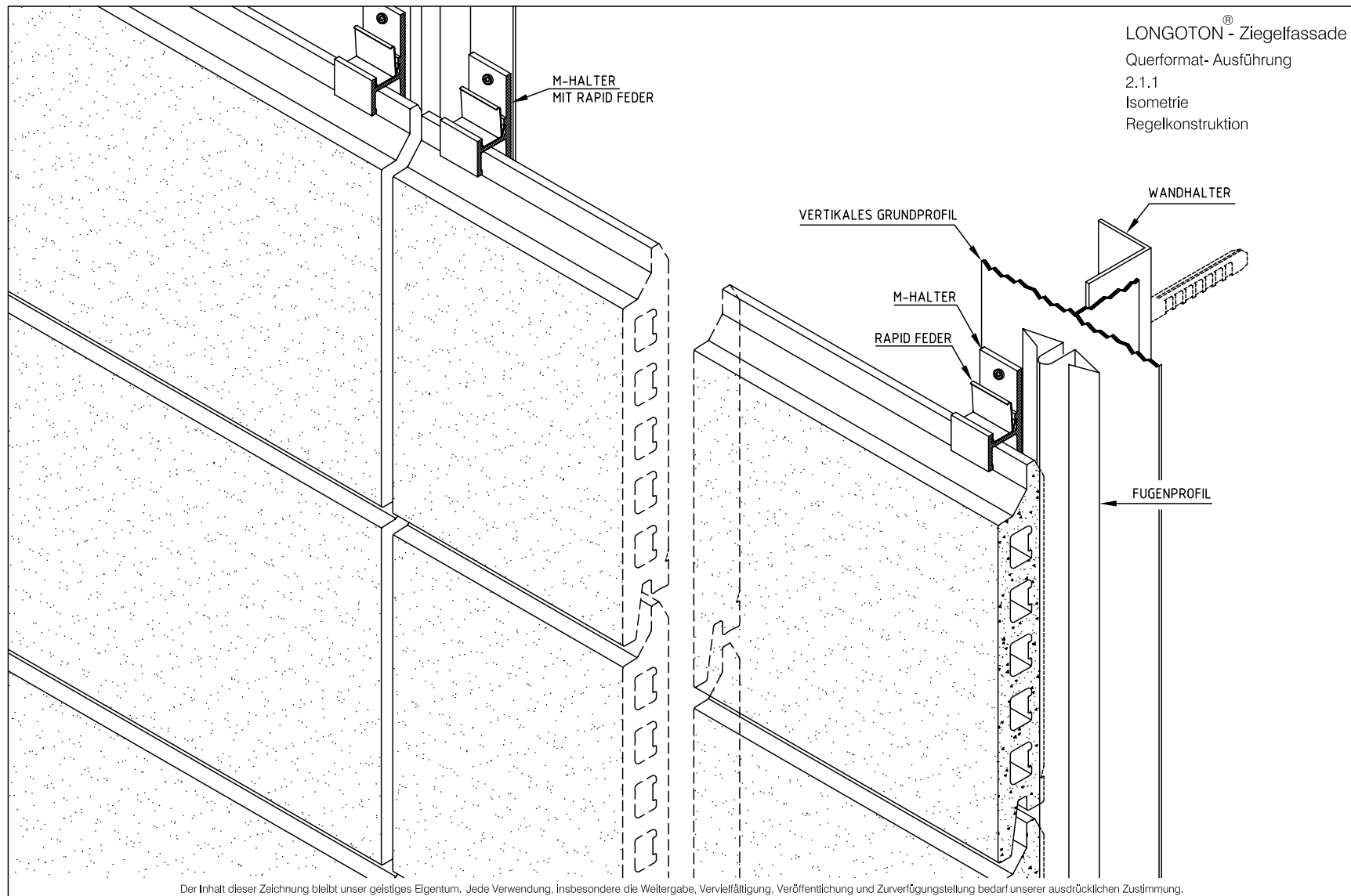

Frontalansicht
Front view
Vue de face

LONGOTON® auf Alu-Unterkonstruktion
LONGOTON® on aluminium substructure
LONGOTON® sur ossature en aluminium

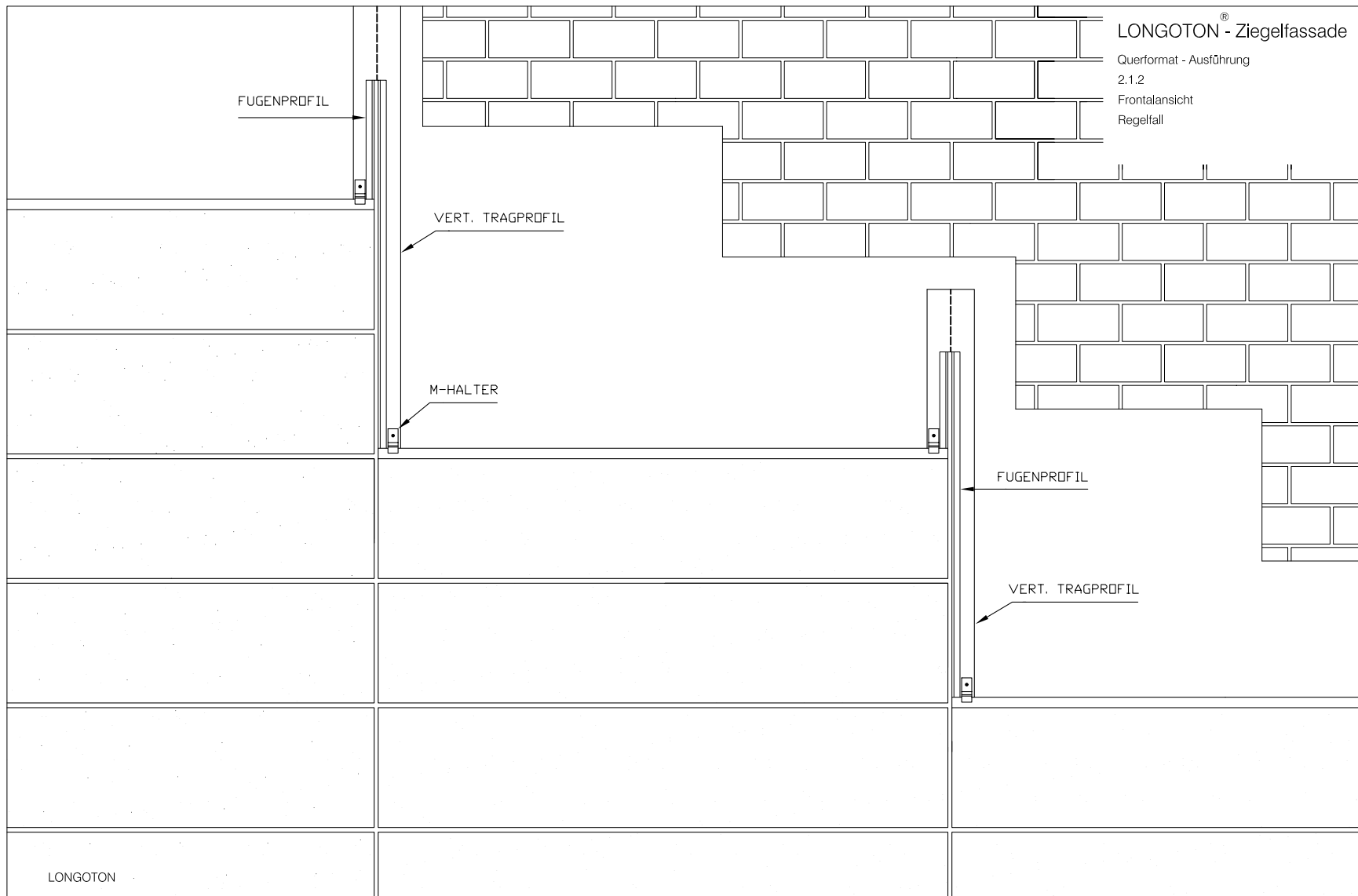

FUGENPROFILE

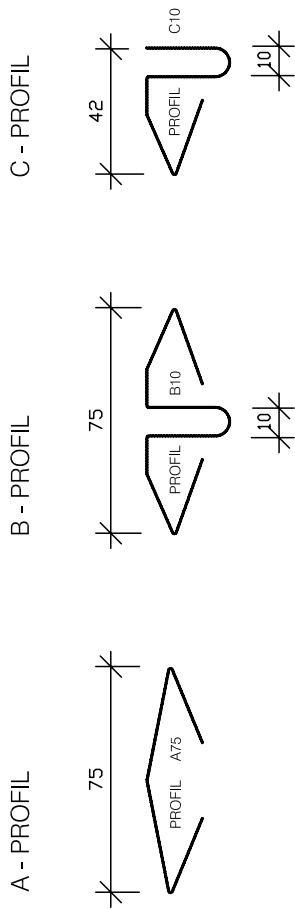

PLATTENHALTER

RAPIDSYSTEM

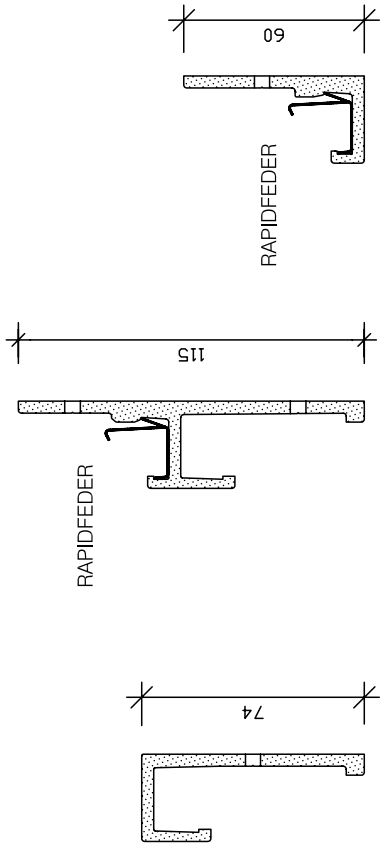

O - HALTER RAPID

M - HALTER RAPID

U - HALTER RAPID

NORMALSYSTEM

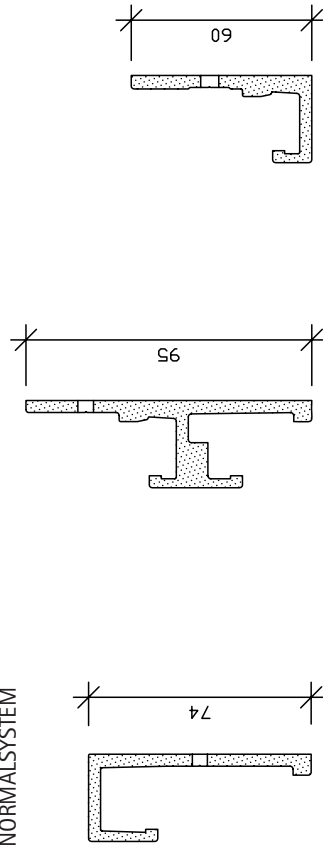

O - HALTER NORMAL

M - HALTER NORMAL

U - HALTER NORMAL

Der Inhalt dieser Zeichnung bleibt unser geistiges Eigentum. Jede Verwendung, insbesondere die Weitergabe, Vervielfältigung, Veröffentlichung und Zurverfügungstellung bedarf unserer ausdrücklichen Zustimmung.

Regeldetail

LONGOTON® Systemteile



MOEDING Keramikfassaden
 Ludwig - Gäringhuber - Str. 1
 84163 Marklköfen
 Tel. +49 (0) 87 32 / 24 6-00
 Fax. +49 (0) 87 32 / 24 6-69

Detail-Nr.

LO-Systemteile

Datum

04.08.2011

Maßstab

1:1

Maße in mm

MOEDING

Gesamtschnitt
 Overall section
 Vue en coupe (générale)

LONGOTON® auf Alu-Unterkonstruktion
 LONGOTON® on aluminium substructure
 LONGOTON® sur ossature en aluminium

LONGOTON® - Ziegelfassade

Querformat-Ausführung
 2.1.3a V - Schnitt
 Gesamtschnitt
 Regelfall mit Aushebesicherung
 " top - down - Montage "

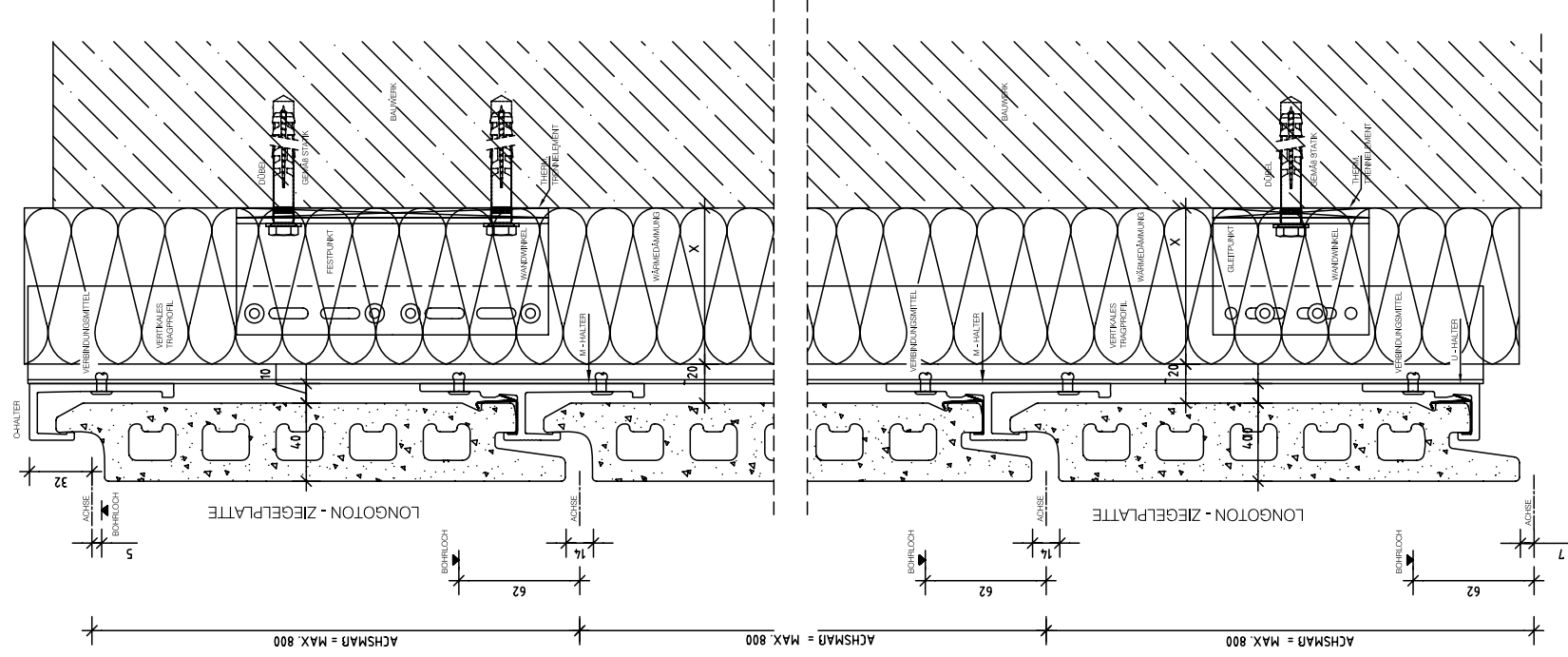

Der Inhalt dieser Zeichnung bleibt unser geistiges Eigentum. Jede Verwendung, insbesondere die Weitergabe, Veröffentlichung, Verfügbarmachung und Zuverfügungstellung bedarf unserer ausdrücklichen Zustimmung.

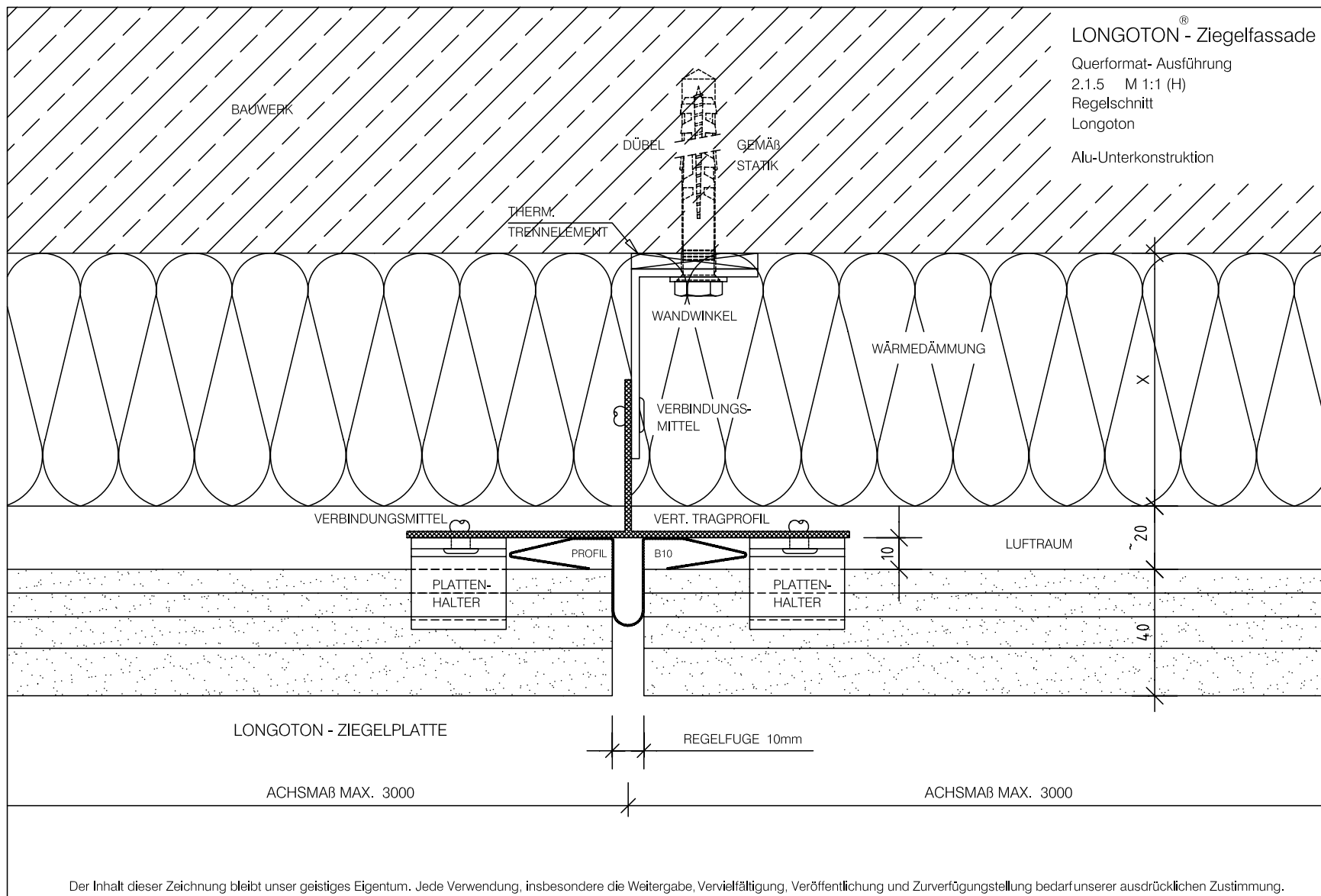

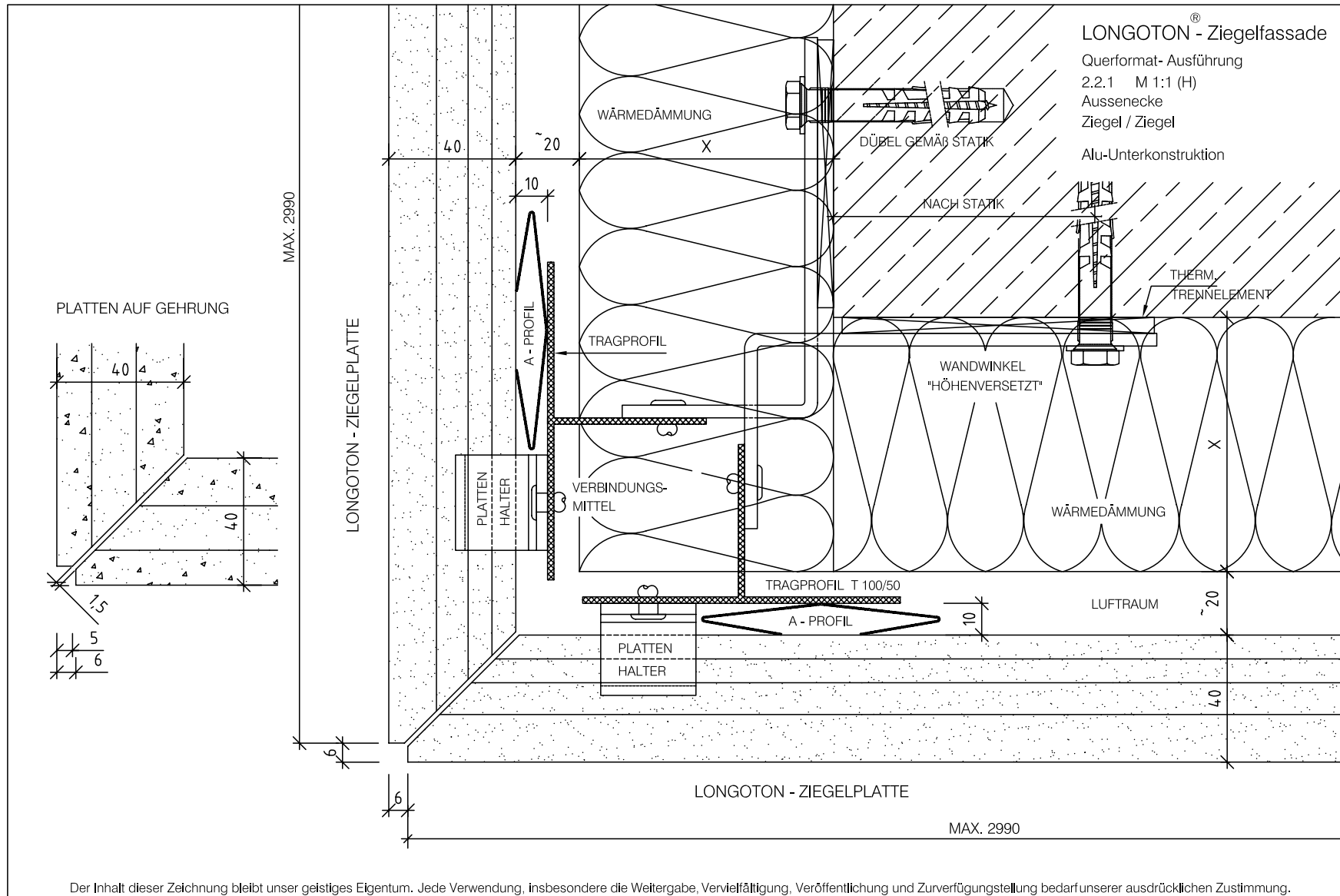

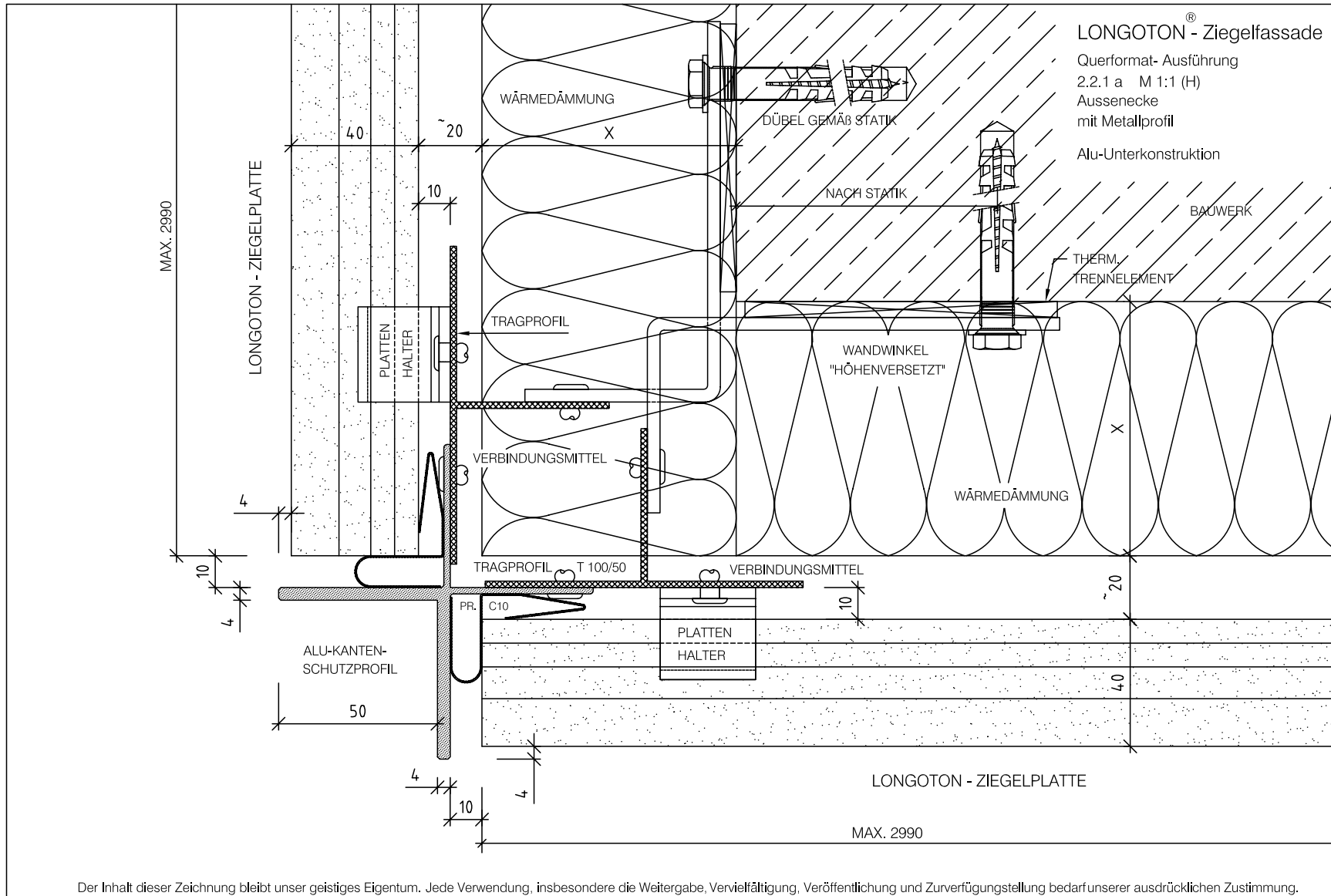

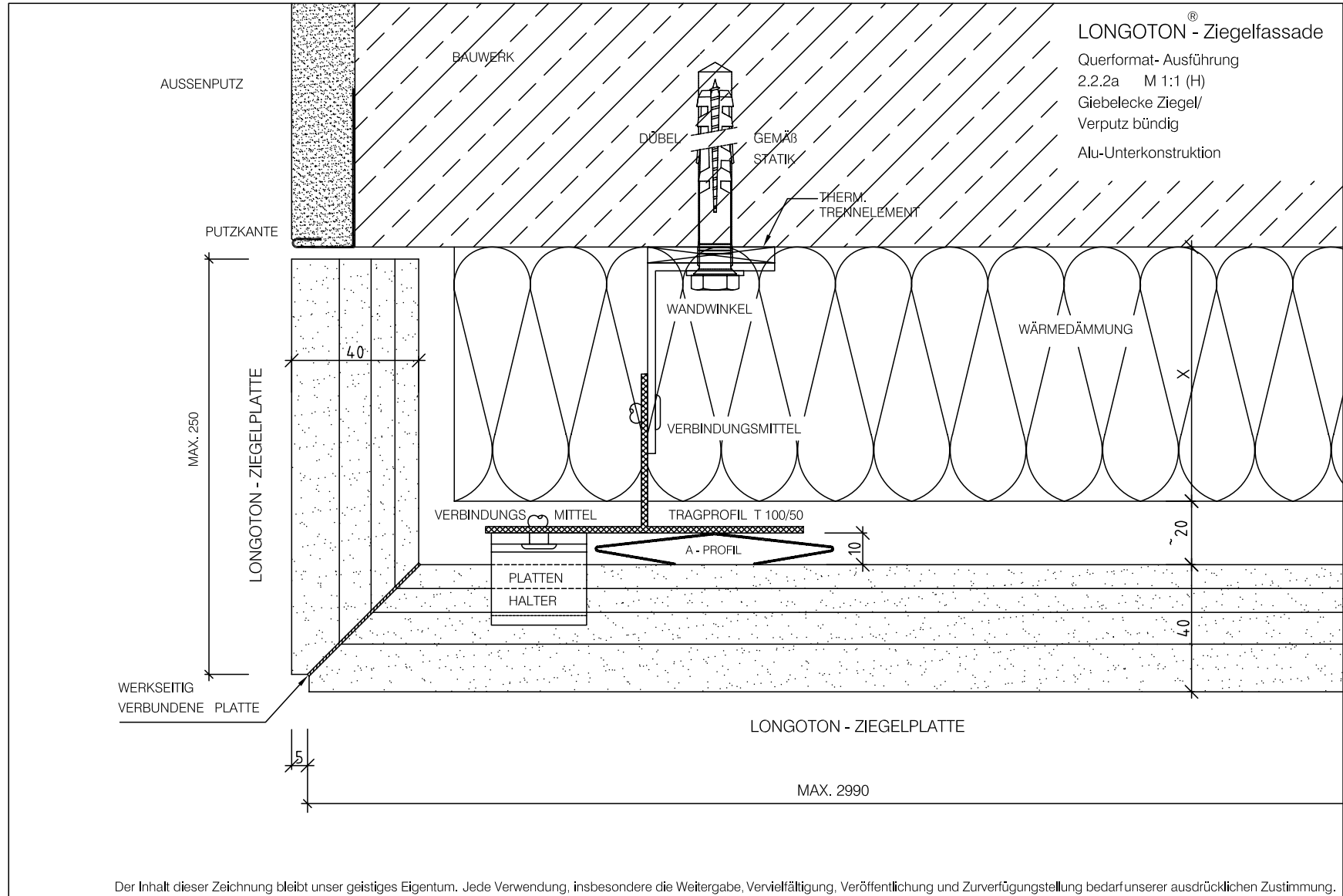

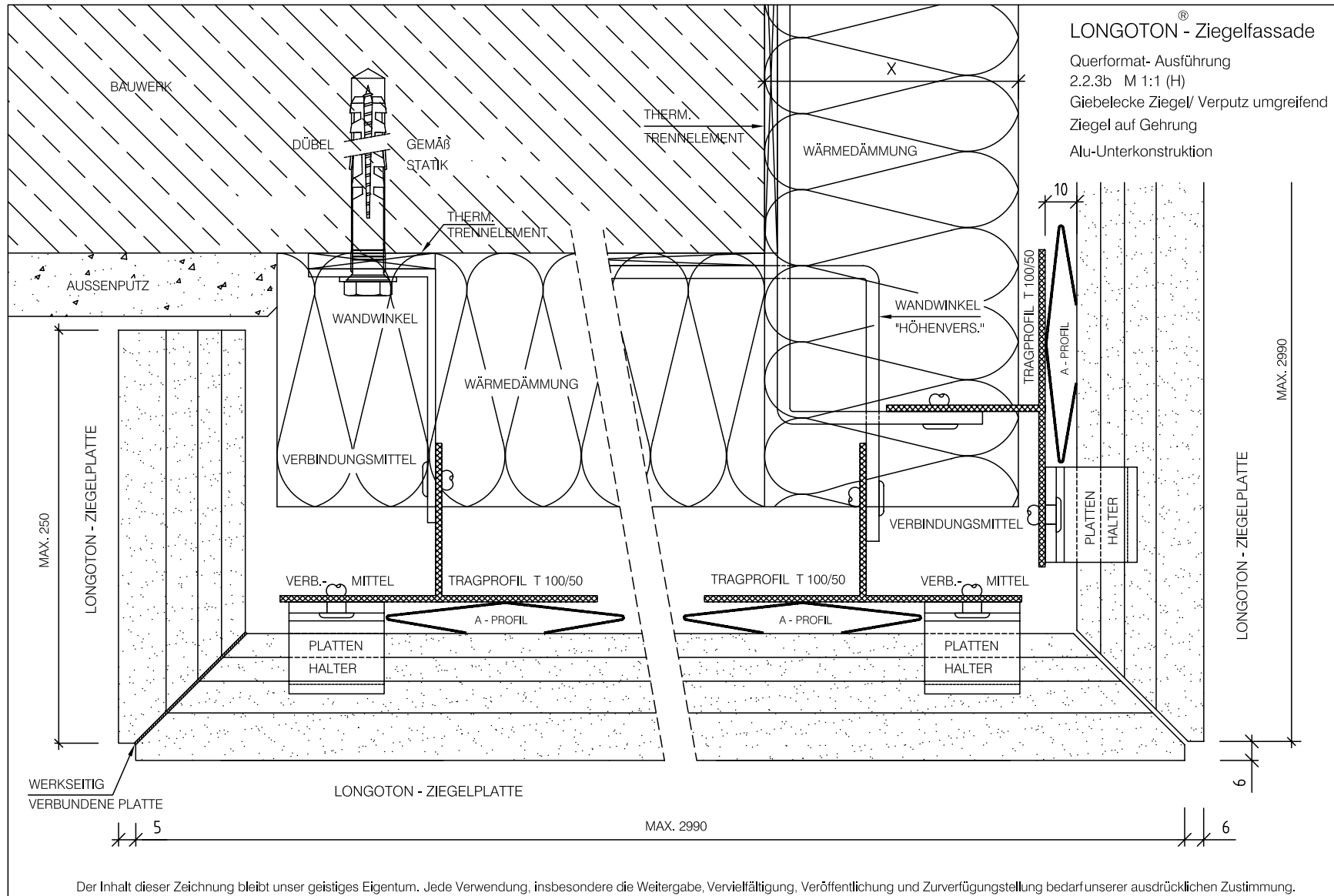

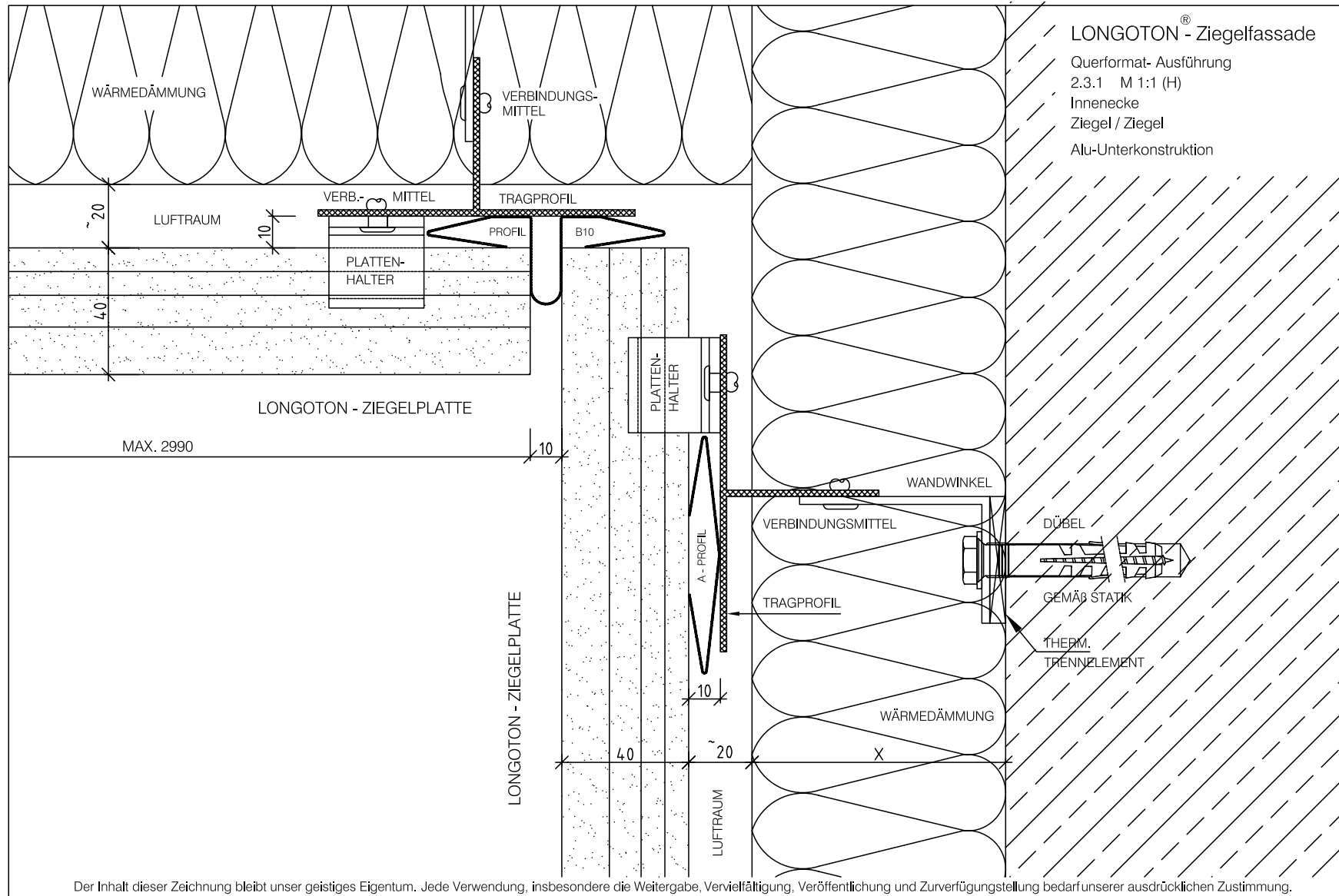

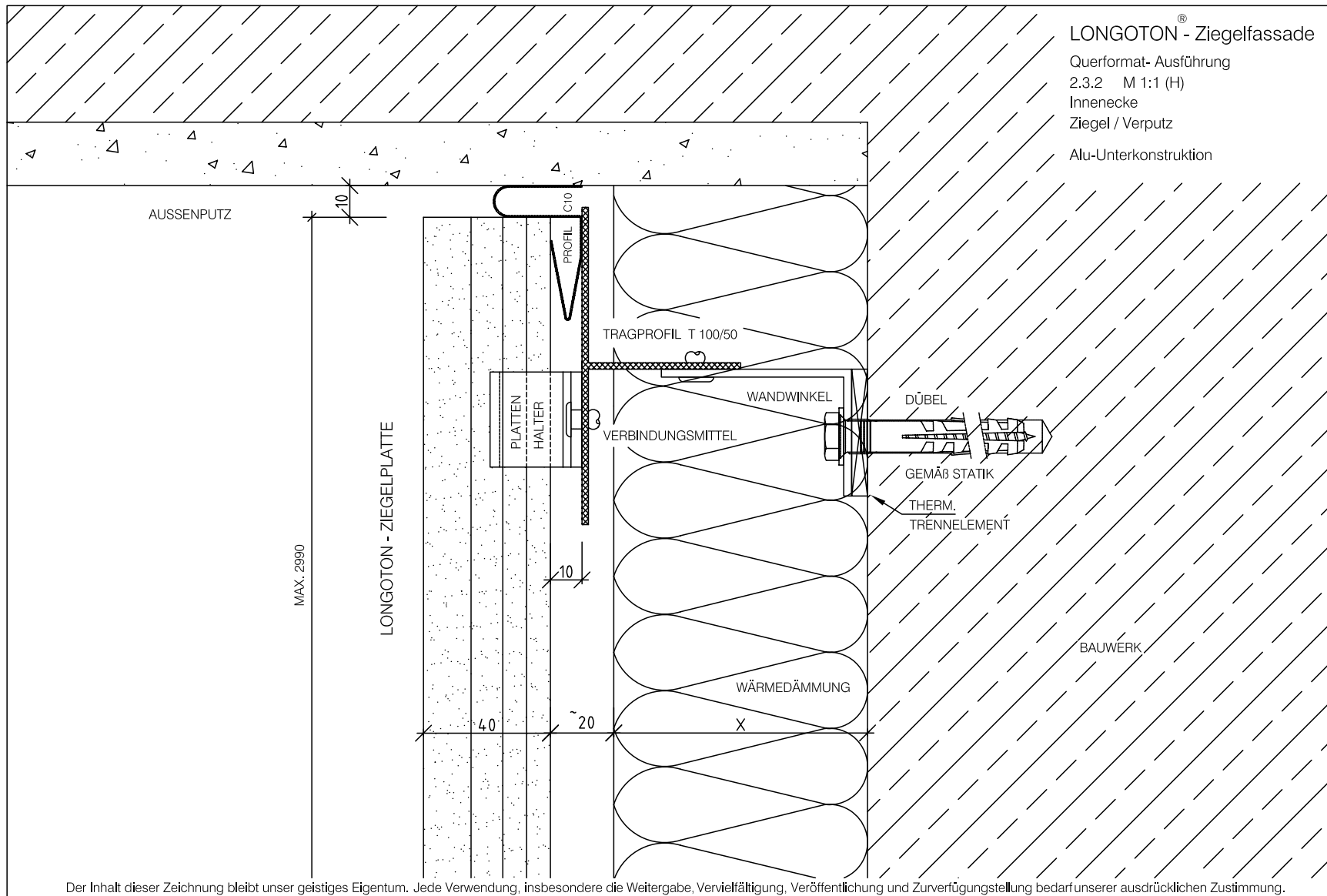

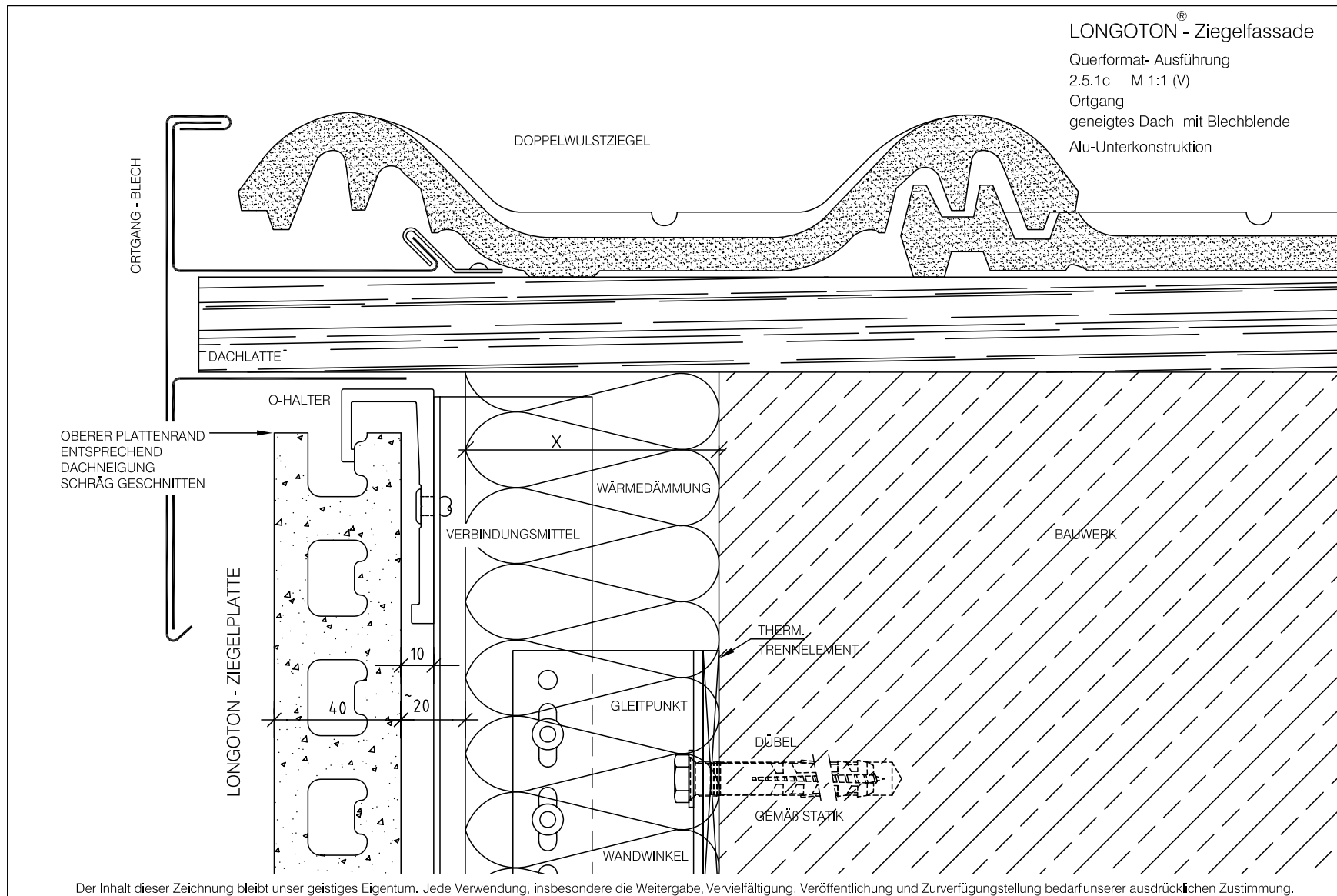

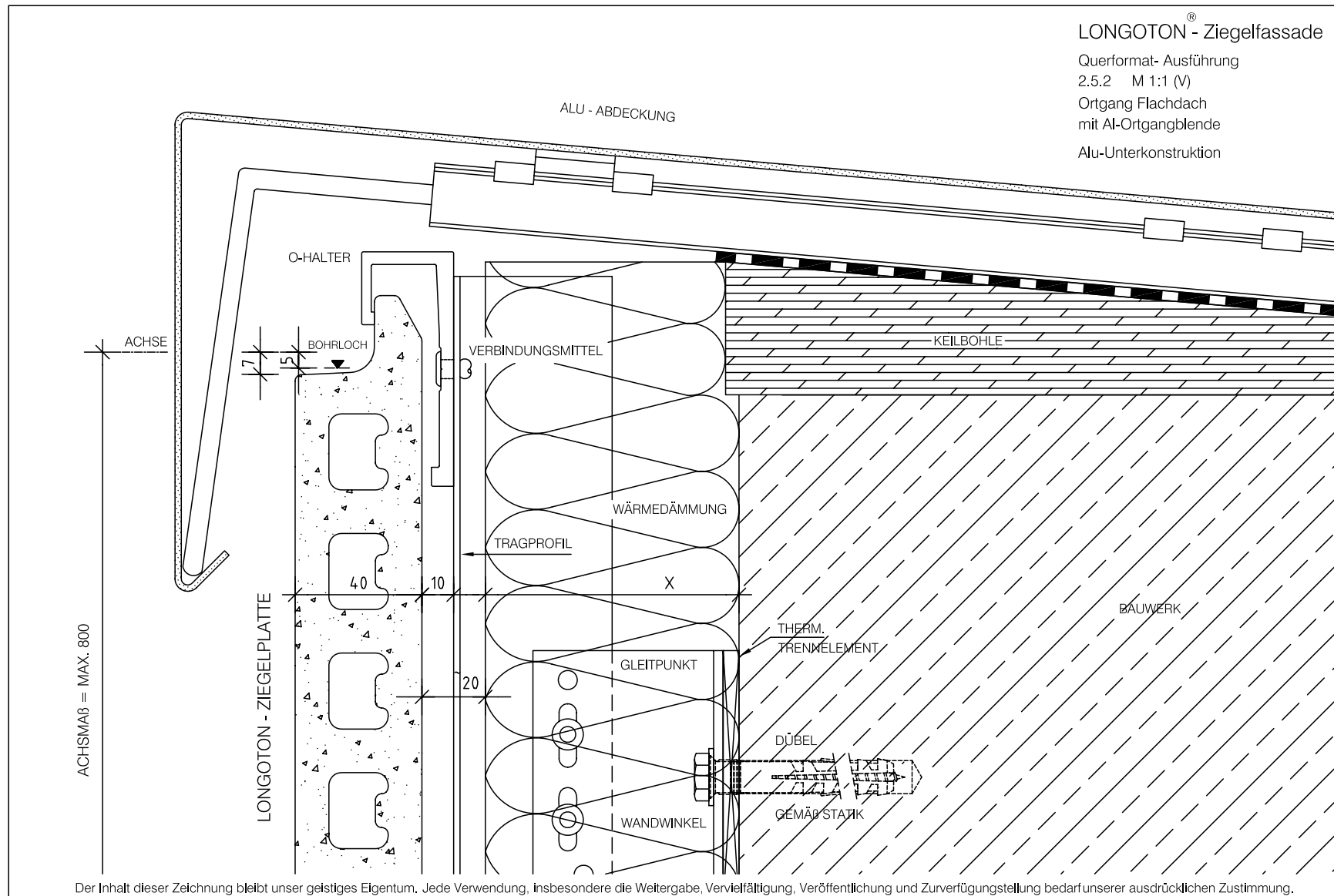

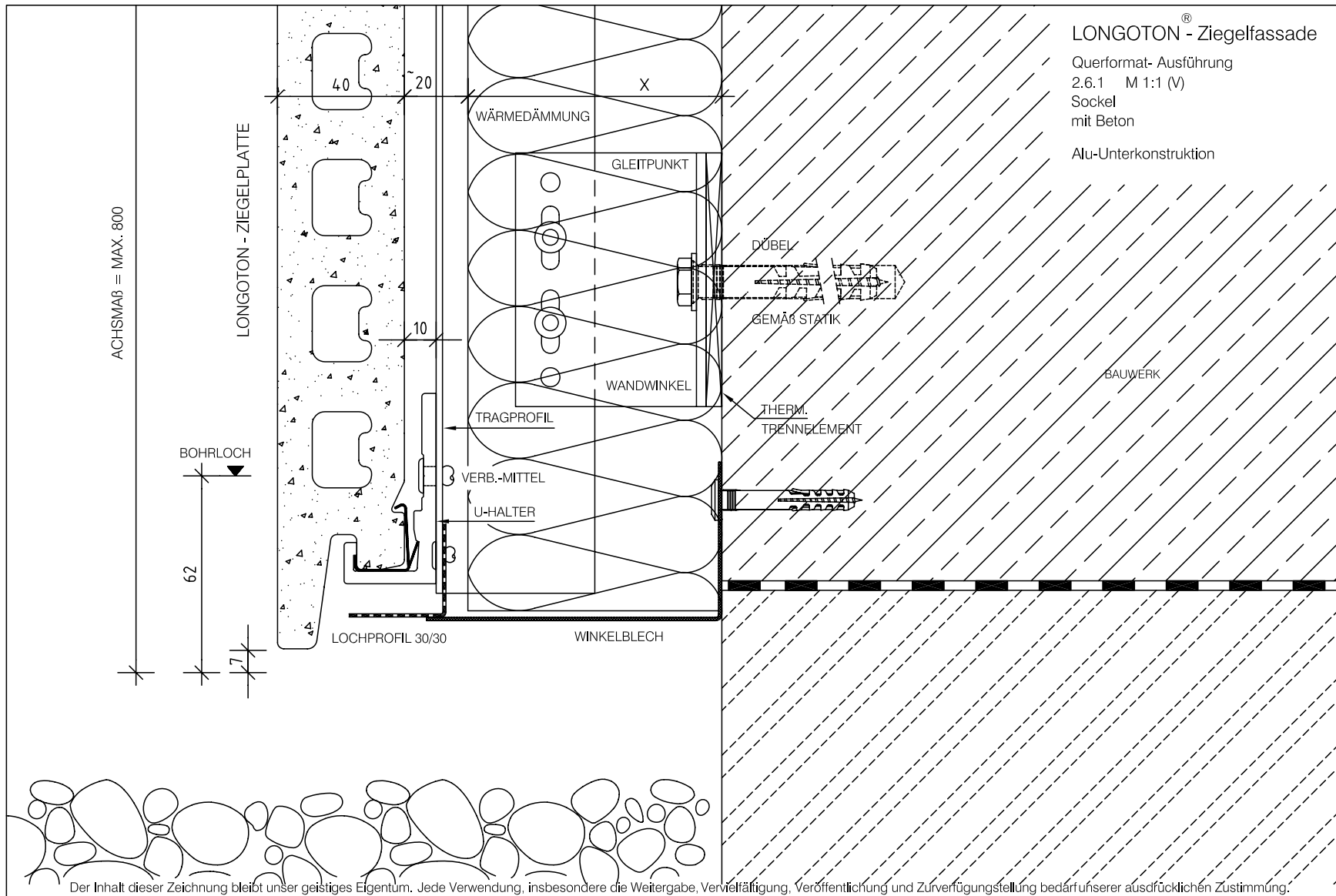

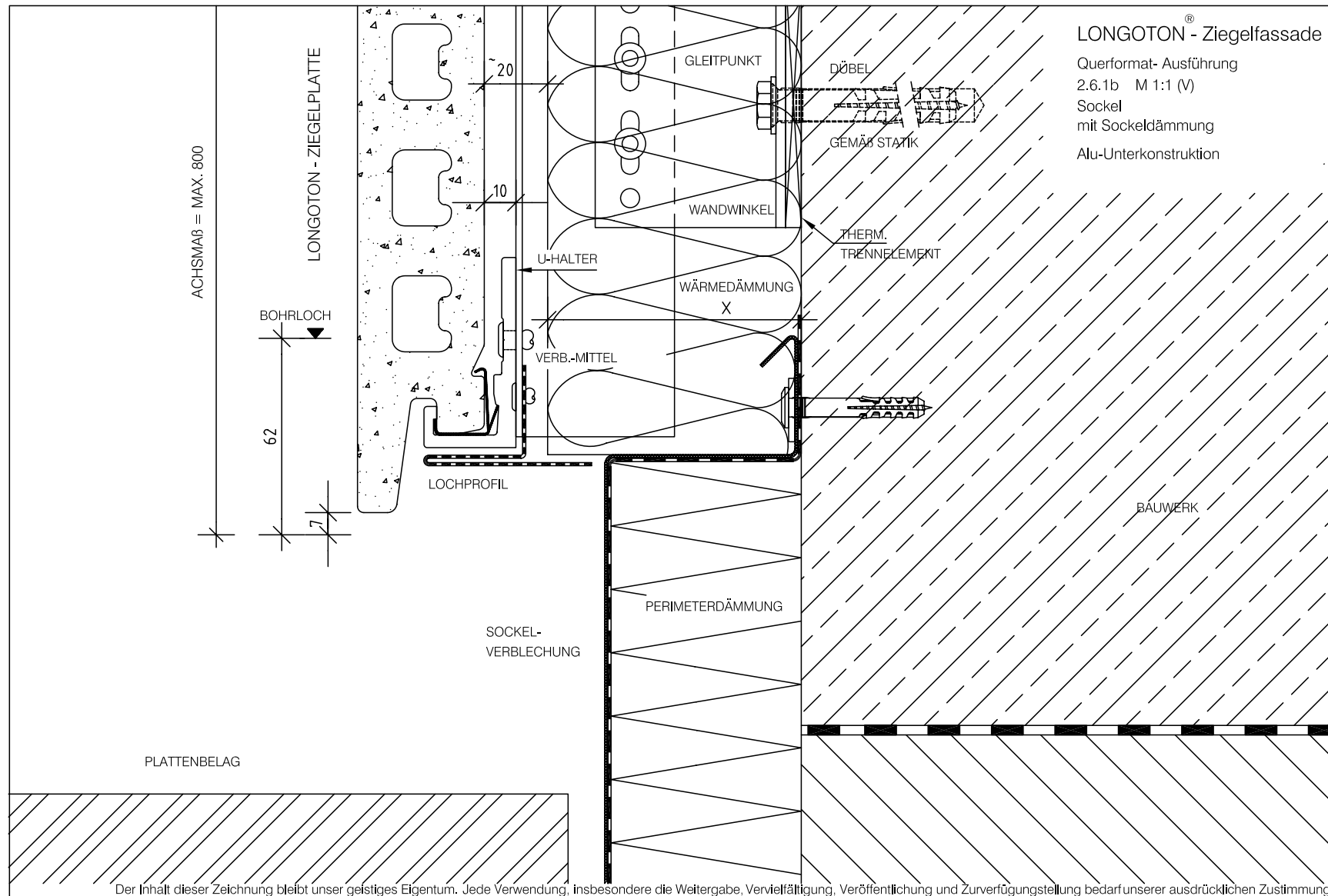

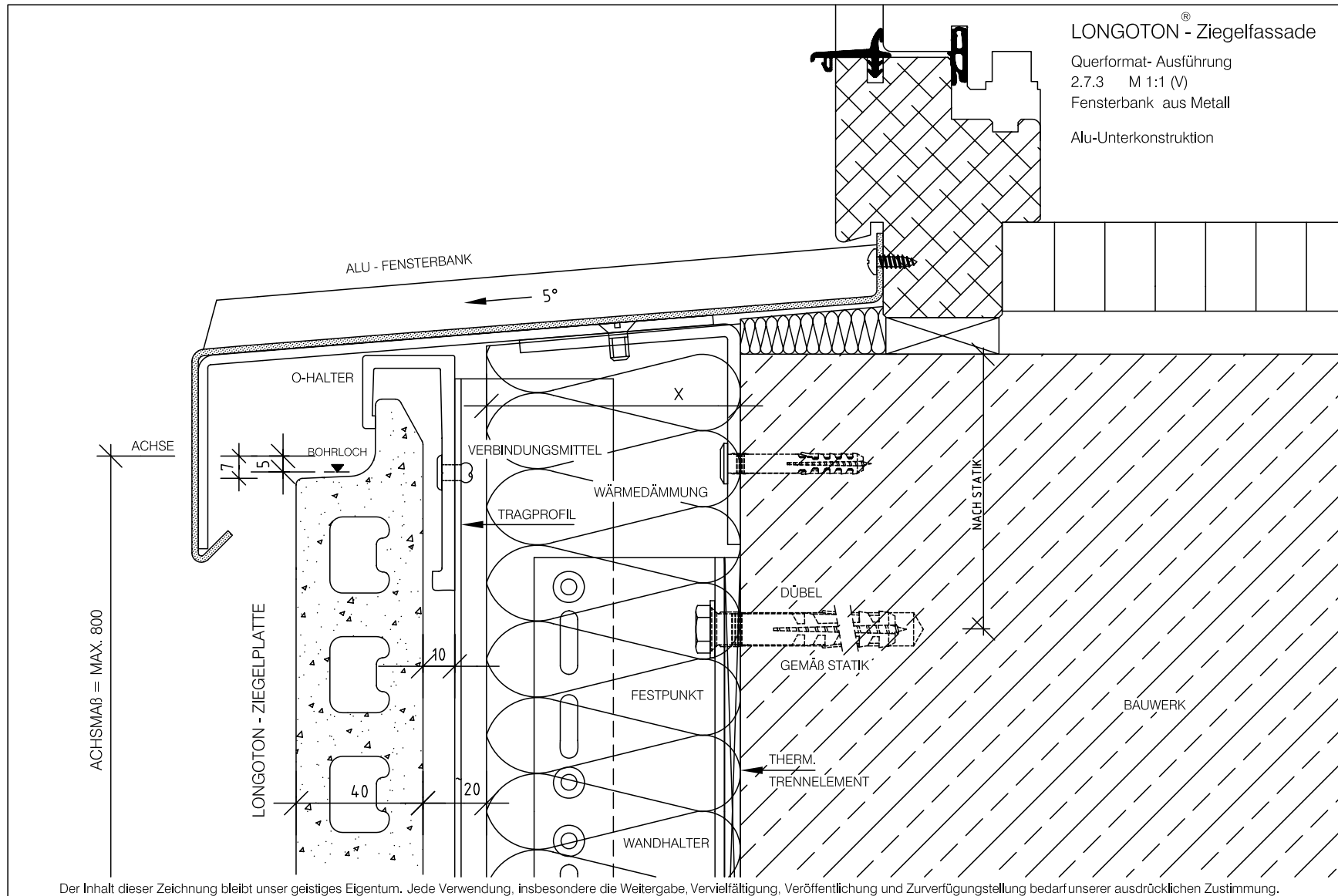

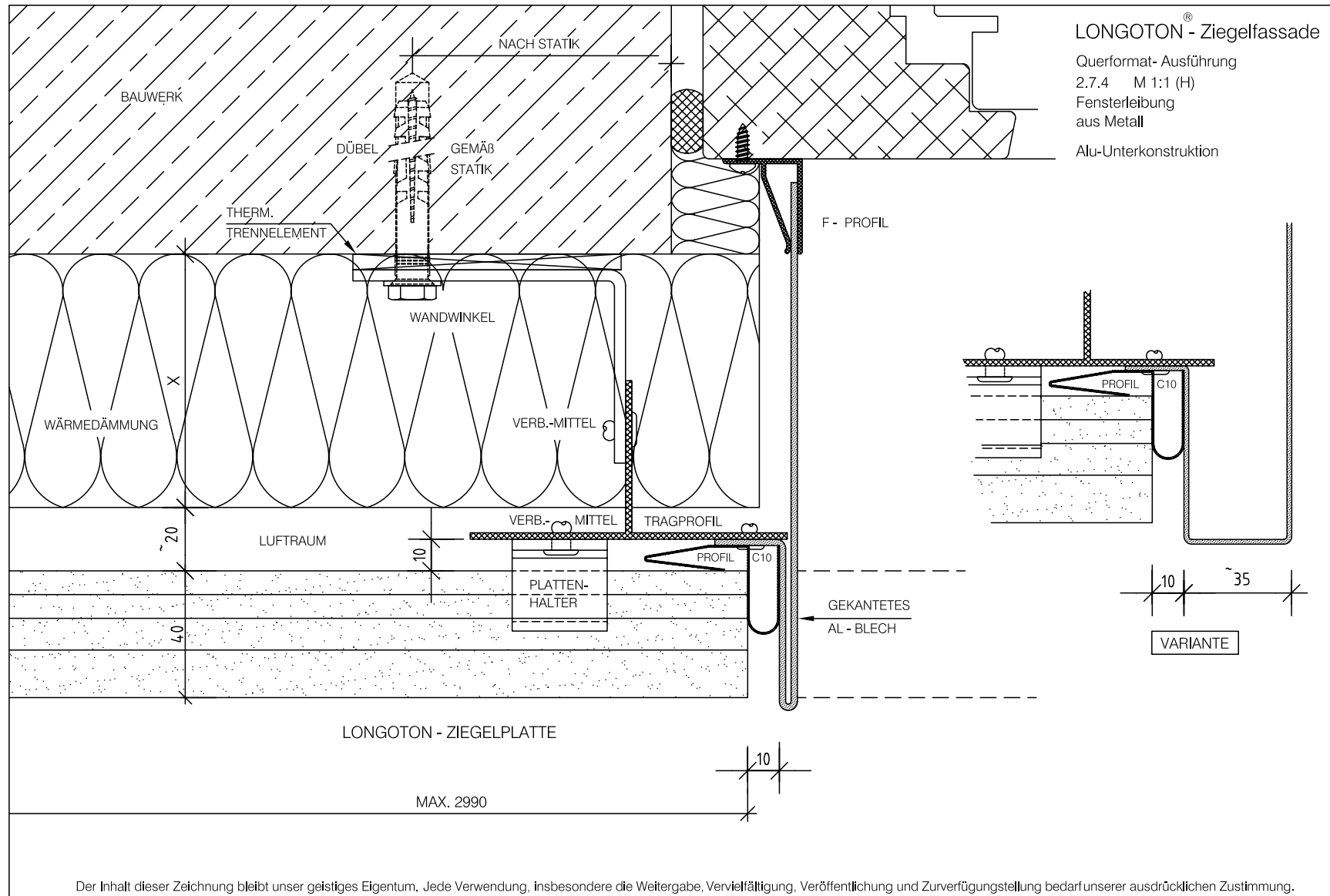

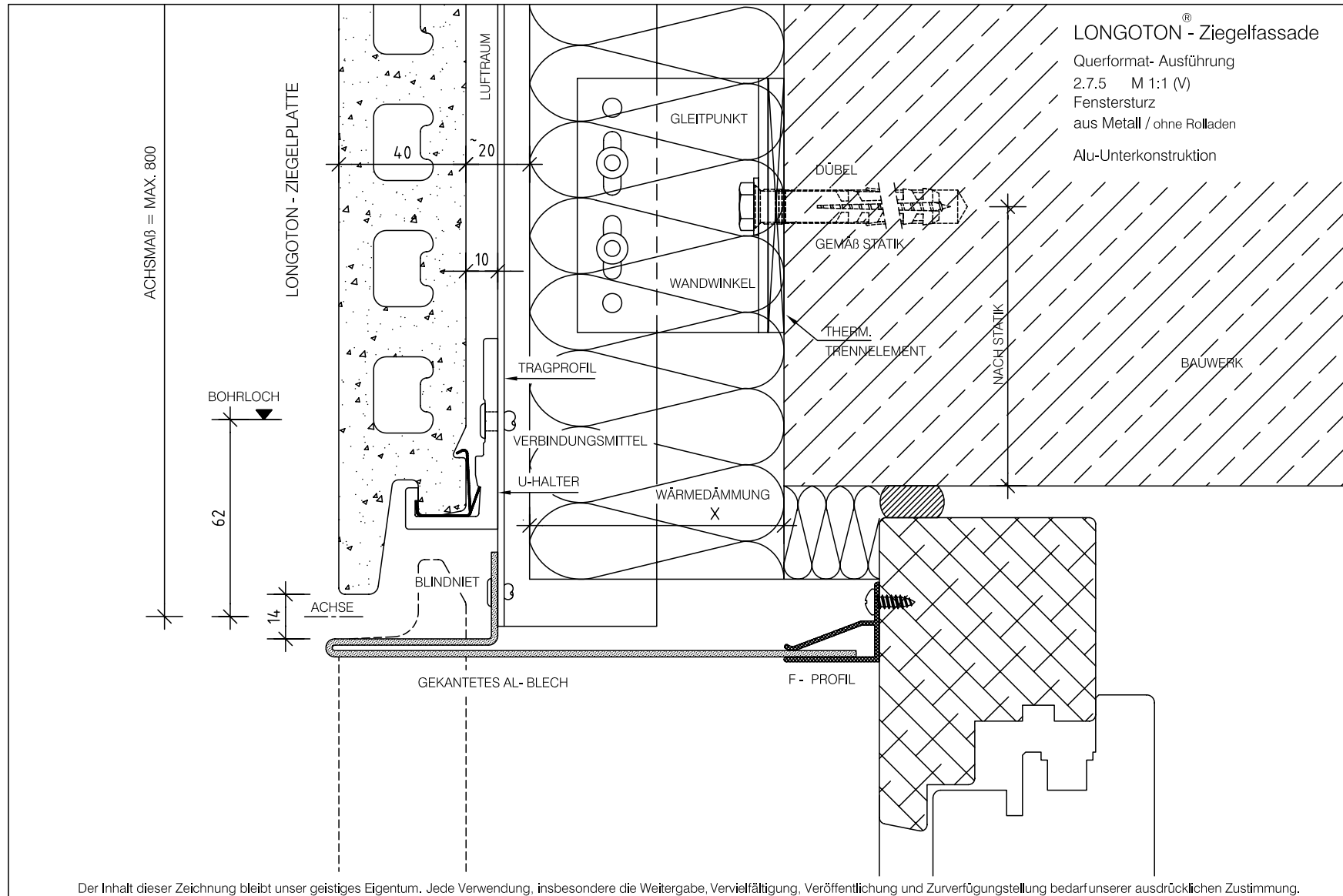

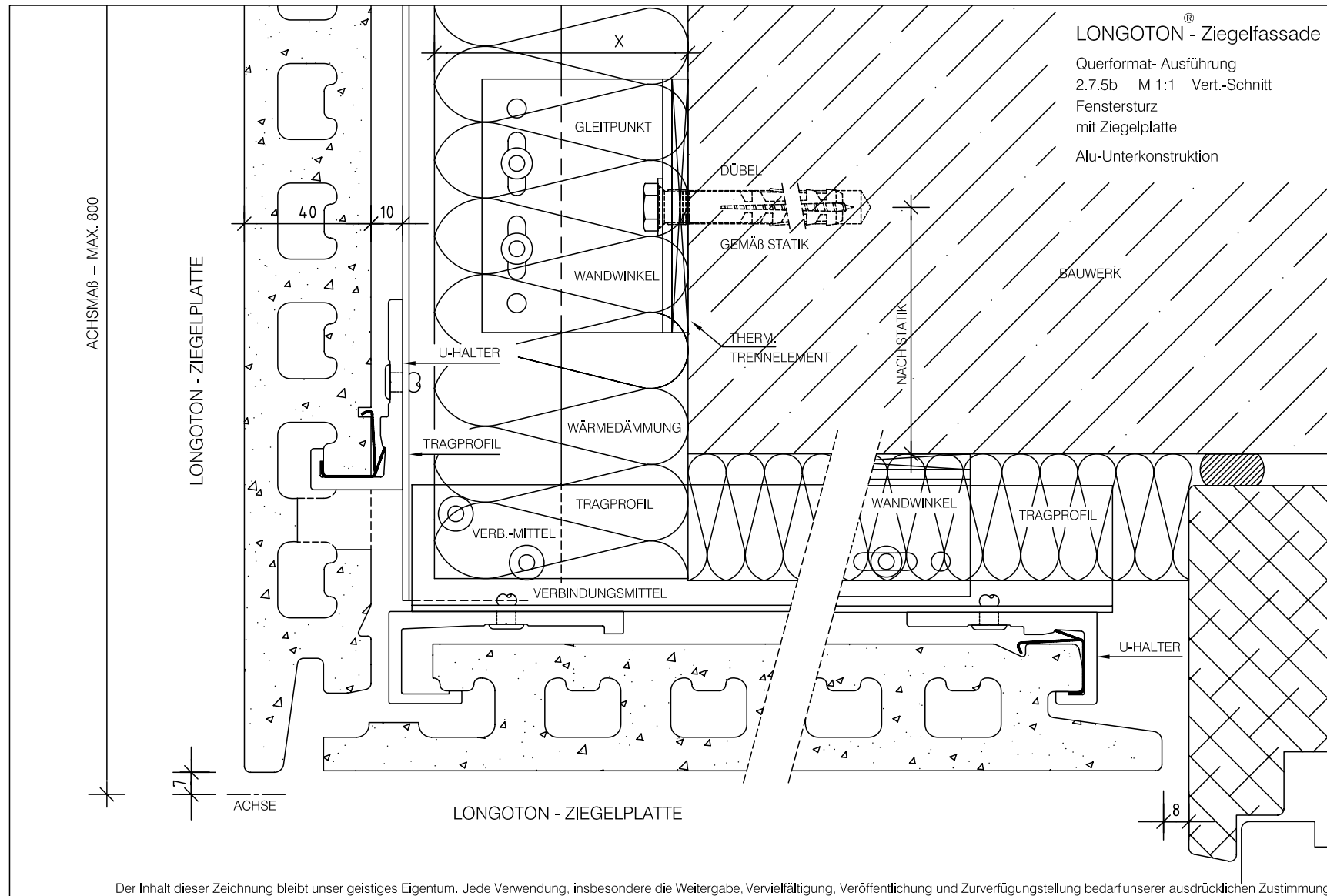

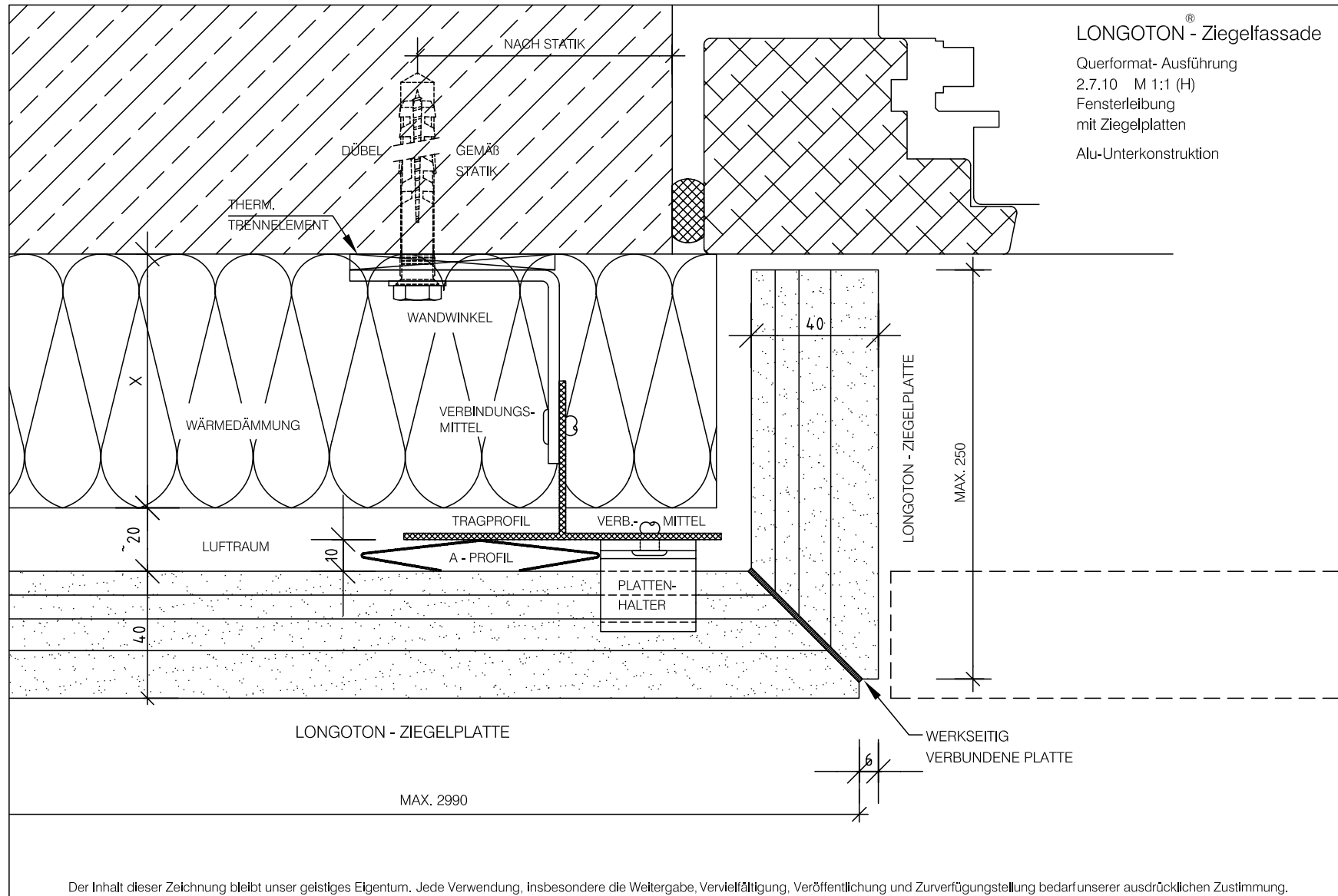

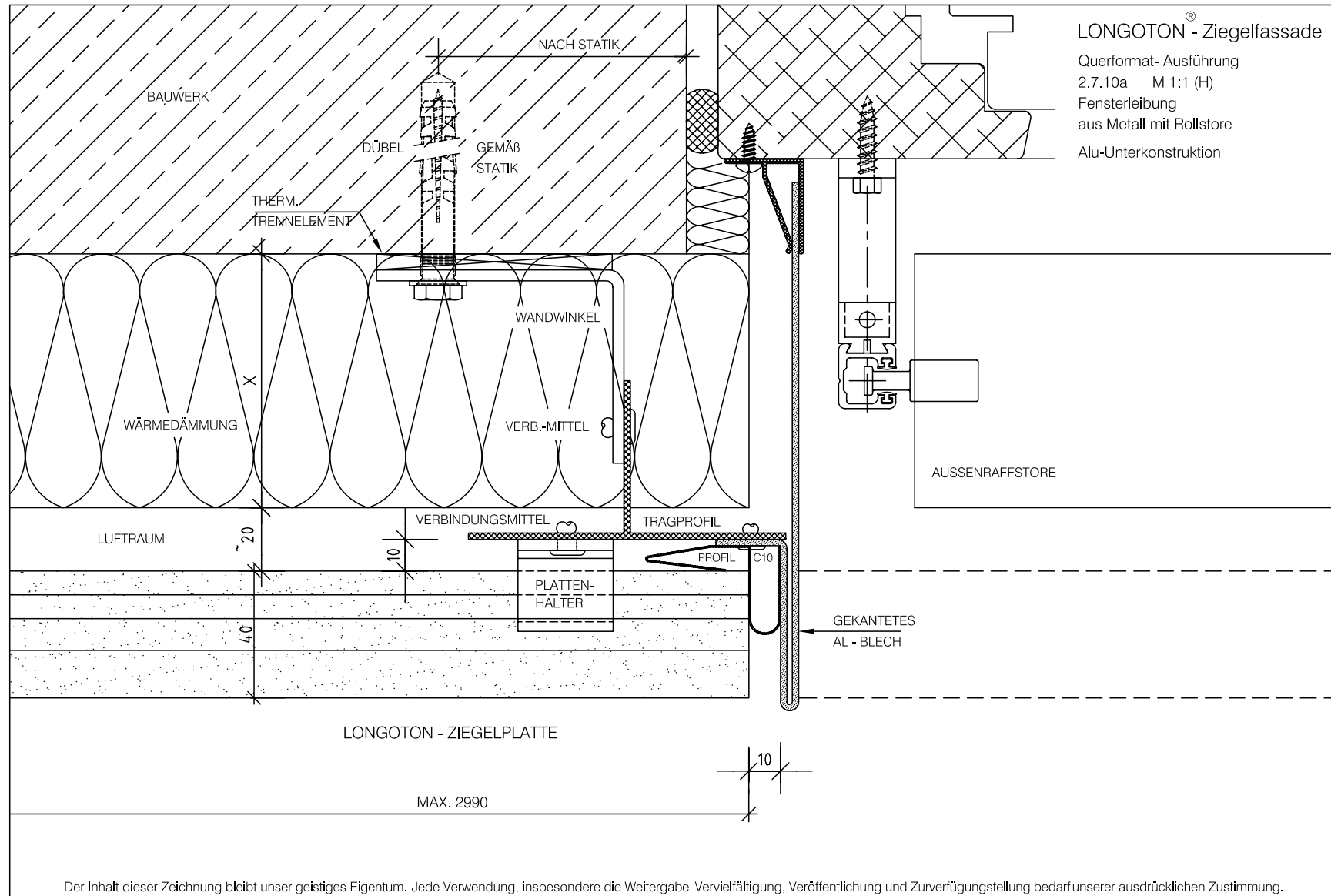

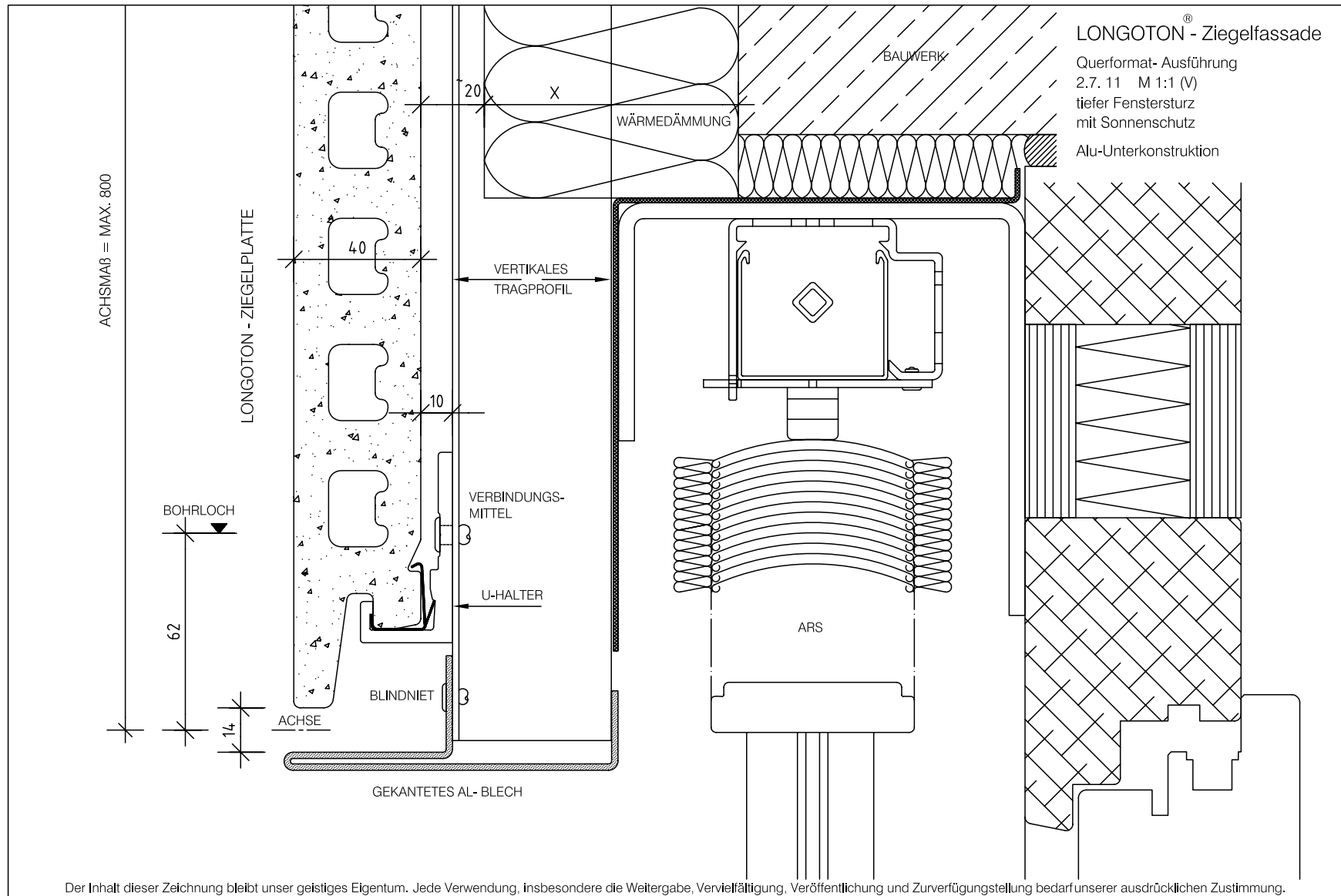

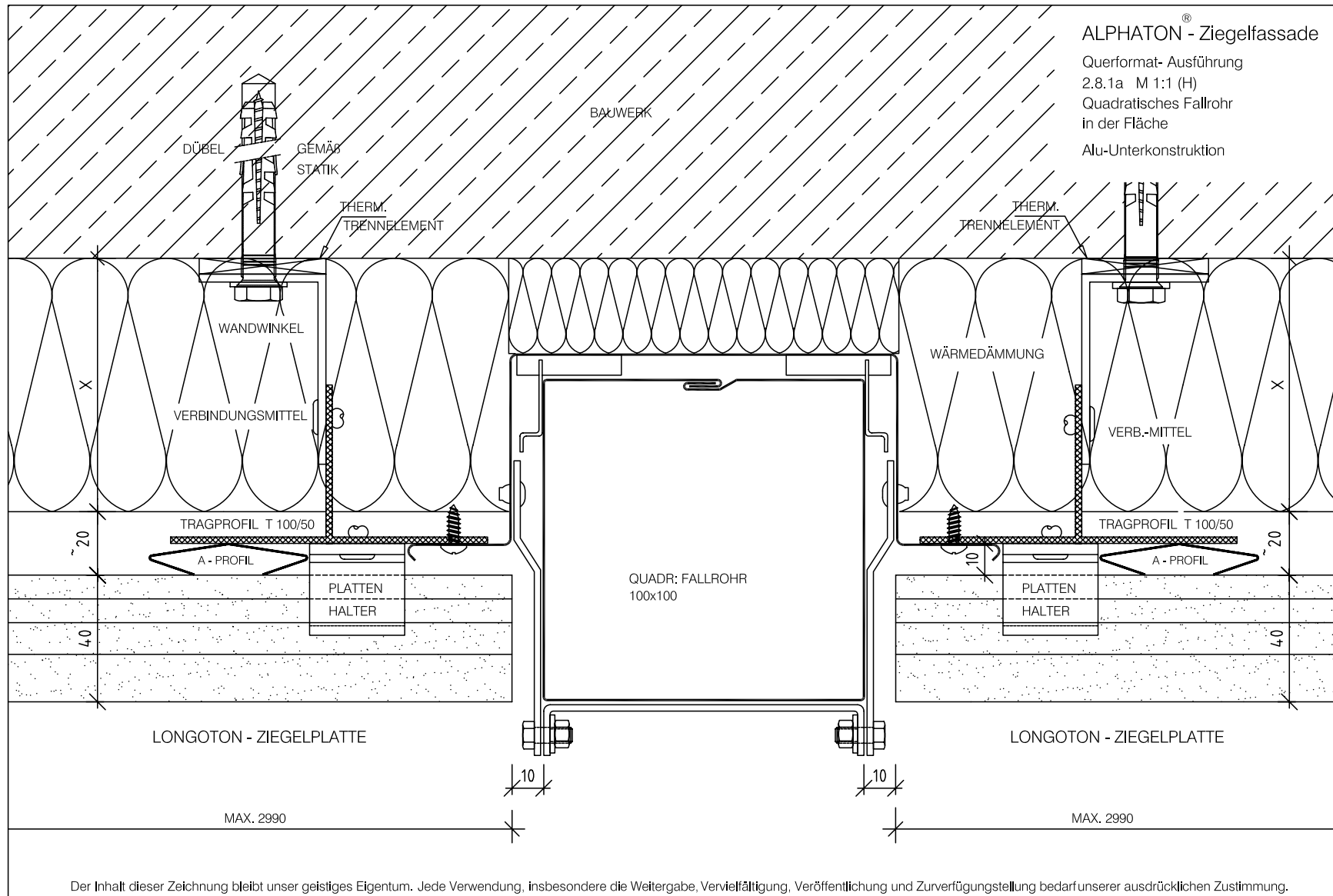

Fallrohre in der Fläche
 Downpipes integrated in the façade
 Accents verticaux intégrés à la façade

LONGOTON® auf Alu-Unterkonstruktion
 LONGOTON® on aluminium substructure
 LONGOTON® sur ossature en aluminium

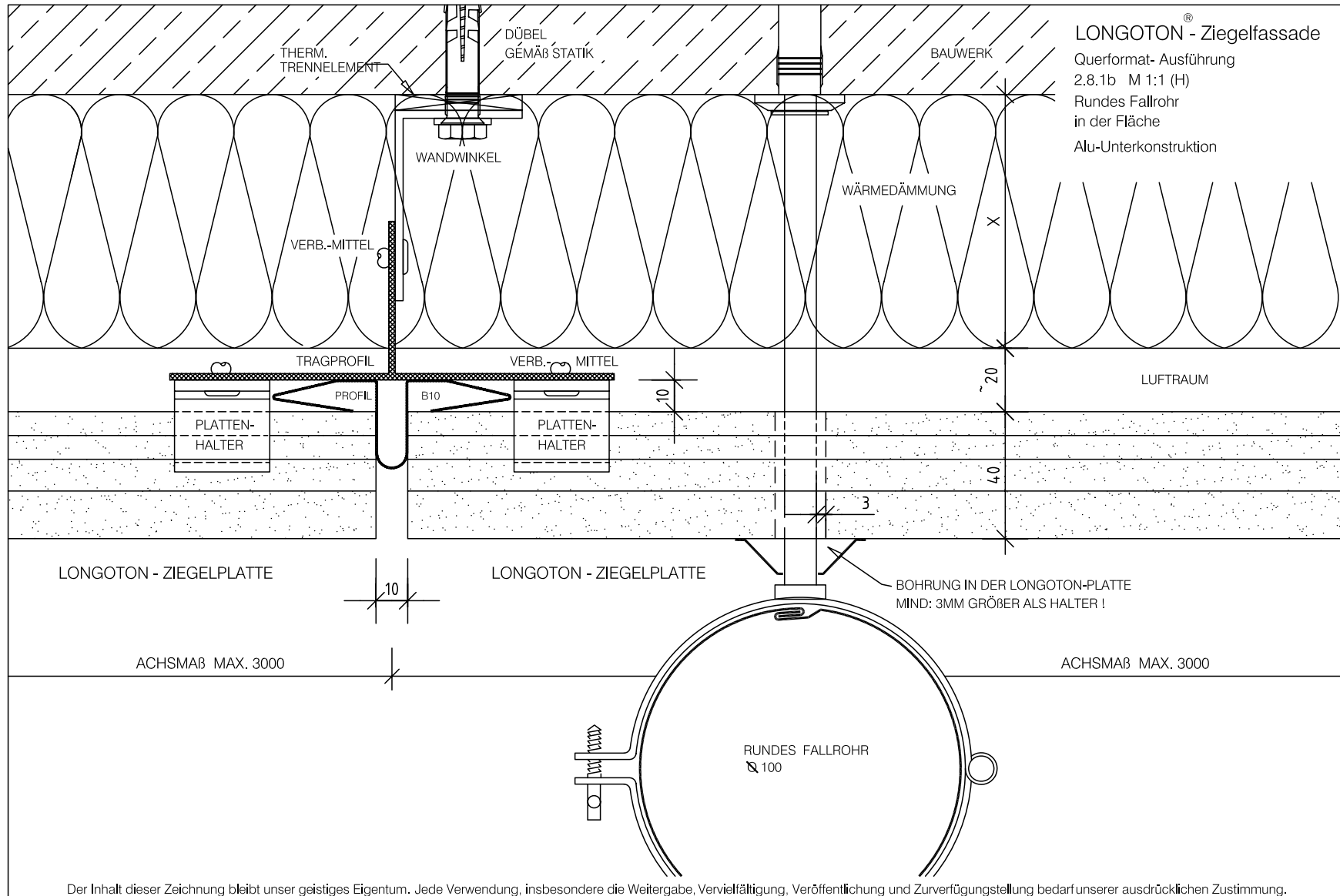



Moeding Keramikfassaden GmbH
Ludwig-Girnghuber-Straße 1
84163 Marklkofen
Germany

Telefon +49 (0) 87 32 / 246 00
Telefax +49 (0) 87 32 / 246 69

E-Mail: [info @moeding.de](mailto:info@moeding.de)
www.moeding.de