

L2



Detailheft 05-2015
ALPHATON®-Ziegelfassade L²

Detail book / Cahier technique



MOEDING

Moeding Keramikfassaden GmbH
Ludwig-Girnghuber-Straße 1
84163 Marklkofen
Germany

Telefon +49 (0) 87 32 / 246 00
Telefax +49 (0) 87 32 / 246 69

E-Mail: info@moeding.de
www.moeding.de

Vorschläge zur Ausführung von MOEDING Alphonat Ziegelfassaden mit L² Unterkonstruktionssystem.

Proposal for the realization of MOEDING Alphonat clay tile facade with L² Sub construction.

Propositions pour la réalisation de façades en terre cuite MOEDING Alphonat avec sous-construction L².

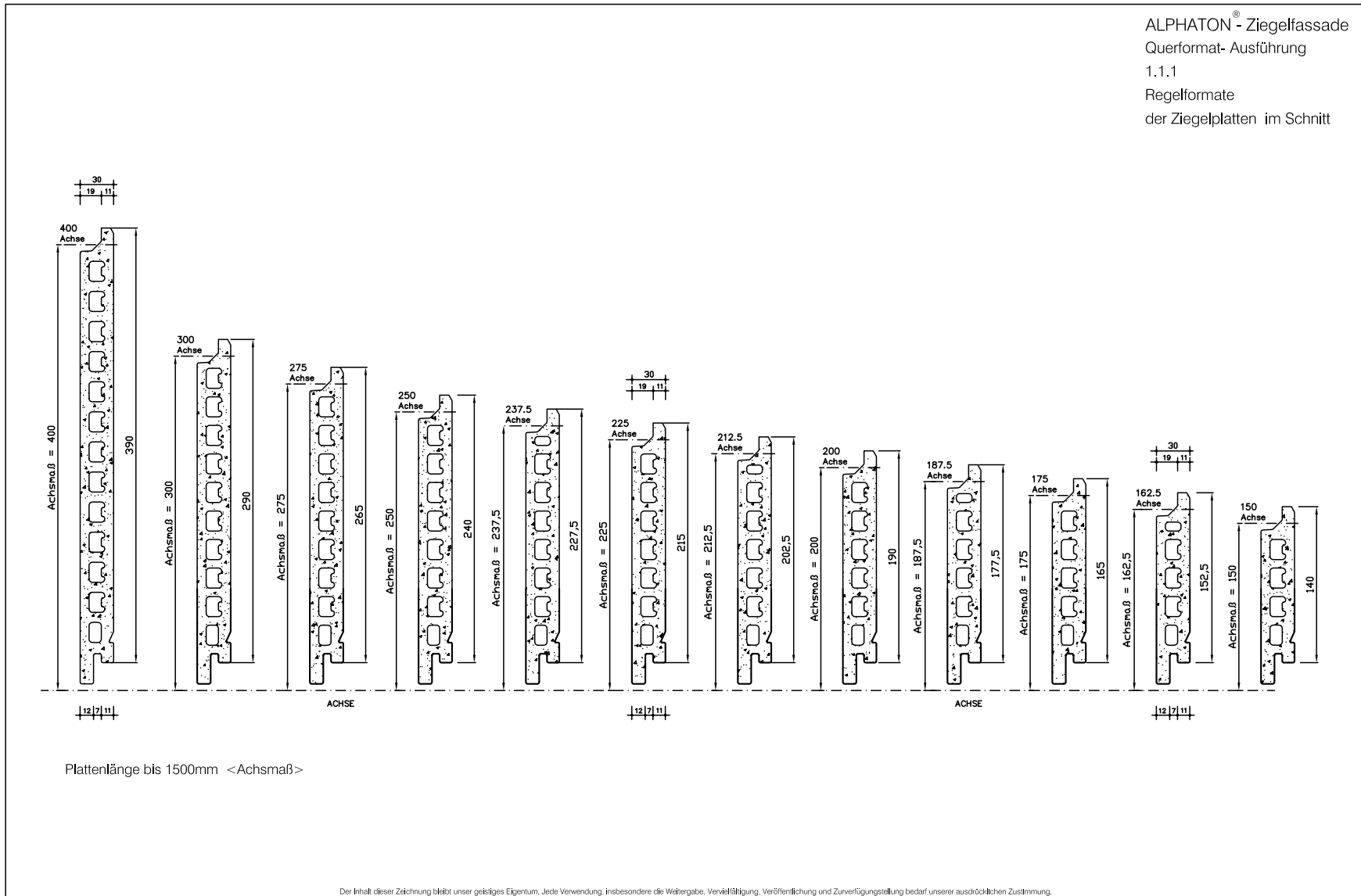

QUERFORMAT - AUSFÜHRUNG

ALPHATON® - Ziegelfassade
 Querformat- Ausführung
 1.1.2 M 1:2.5
 Regelformate der
 Ziegelplatten
 in der Draufsicht

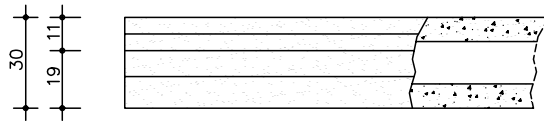

NORMALE PLATTE

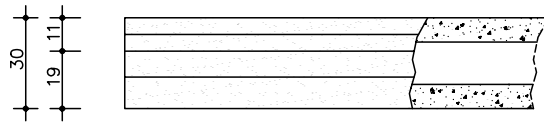
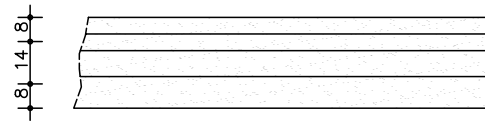

PLATTE MIT GEHRUNGSSCHNITT RECHTS

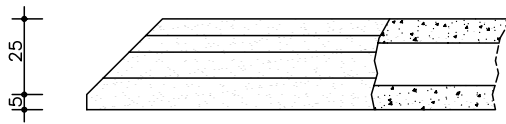
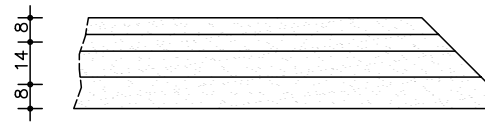

PLATTE MIT GEHRUNGSSCHNITT LINKS

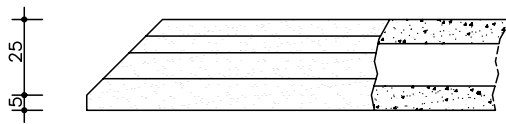
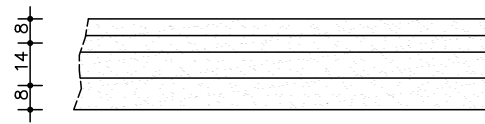

PLATTE MIT GEHRUNGSSCHNITT LINKS + RECHTS

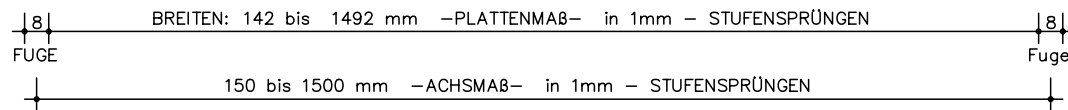
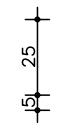
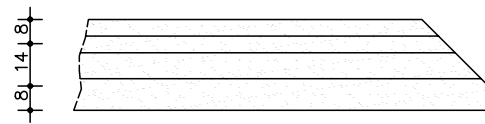

Formate:
 400 mm
 300 mm
 275 mm
 250 mm
 225 mm
 200 mm
 175 mm
 150 mm

Formate:
 237.5 mm
 212.5 mm
 187.5 mm
 162.5 mm

ALPHATON[®] - Ziegelfassade
 Querformat- Ausführung
 1.3.1 M 1:2.5
 Höhenanpassung
 durch Plattenschnitt

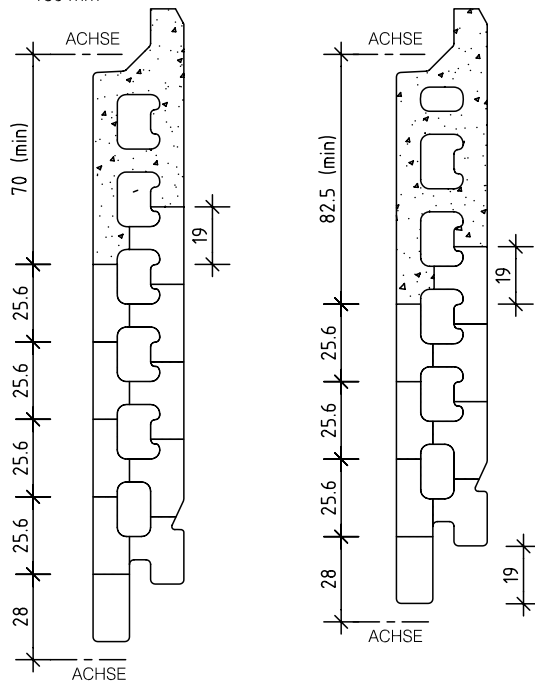

Höhenanpassung in Stufen von 12.5 mm
 durch Regelschnitte
 Platten nur von unten schneiden

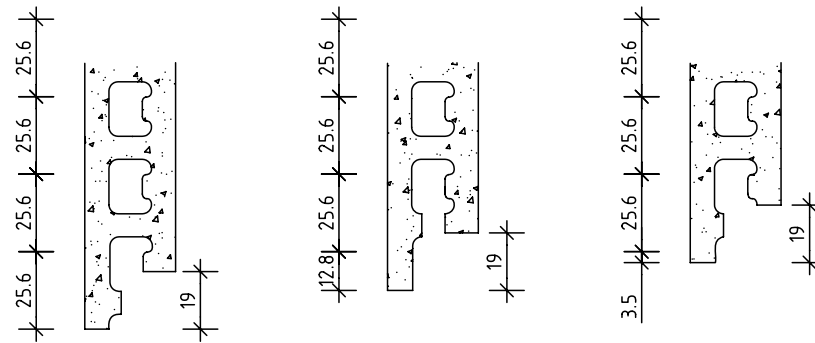





REGELSCHNITT

Schnitte an beliebigen Stellen sind möglich, sollten aber wegen erhöhter Bruchgefahr möglichst vermieden werden.

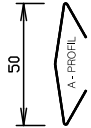
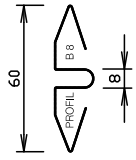
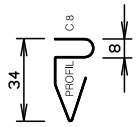
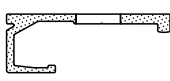
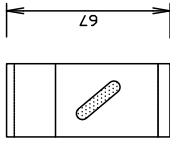
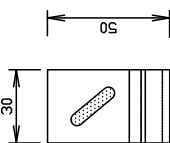
Stufenlose Höhenanpassung
 durch Schnitte an beliebigen Stellen
 Platten nur von unten schneiden

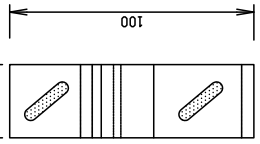
Der Inhalt dieser Zeichnung bleibt unser geistiges Eigentum. Jede Verwendung, insbesondere die Weitergabe, Vervielfältigung, Veröffentlichung und Zurverfügungstellung bedarf unserer ausdrücklichen Zustimmung.

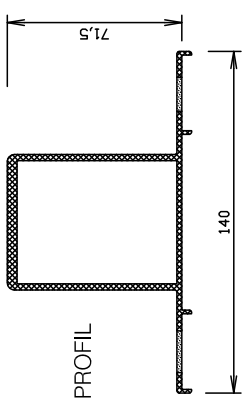
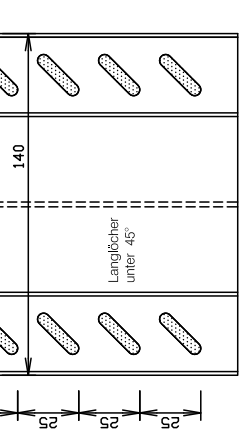
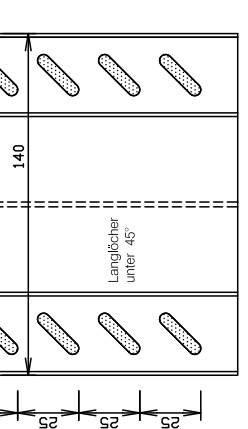
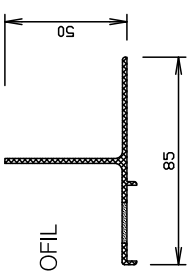
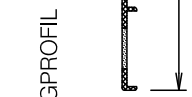
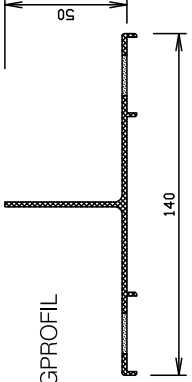
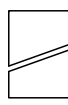
<u>FUGENPROFILE:</u>	A - PROFIL 	B - PROFIL 	C - PROFIL 
<u>PLATTENHALTER:</u>	L ² O-HALTER 	L ² U-HALTER 	L ² U-HALTER 
	L ² M-HALTER 	L ² NIET (POLYGRIP) 4.8x15 K11 ALU/NIRO 	L ² NIET (POLYGRIP) 4.8x15 K11 ALU/NIRO 
<u>L² TRAGPROFILE:</u>	L ² "PLUS" PROFIL 	L ² TRAGPROFIL 	L ² TRAGPROFIL 
	L ² ENDPROFIL 	L ² TRAGPROFIL 	L ² TRAGPROFIL 
Regeldetail	ALPHATON [®] - L ² Systemteile		
zu Detail-Nr. ...	Datum 07.04.2015	Maßstab ----- Maße in mm	L ² Unterkonstruktionssystem
	 MOEDING MOEDING Keramikfassaden Ludwig - Gärtnhuber - Str. 1 84163 Marklkofen Tel. +49 (0) 87 32 / 24 6-00 Fax. +49 (0) 87 32 / 24 6-69		

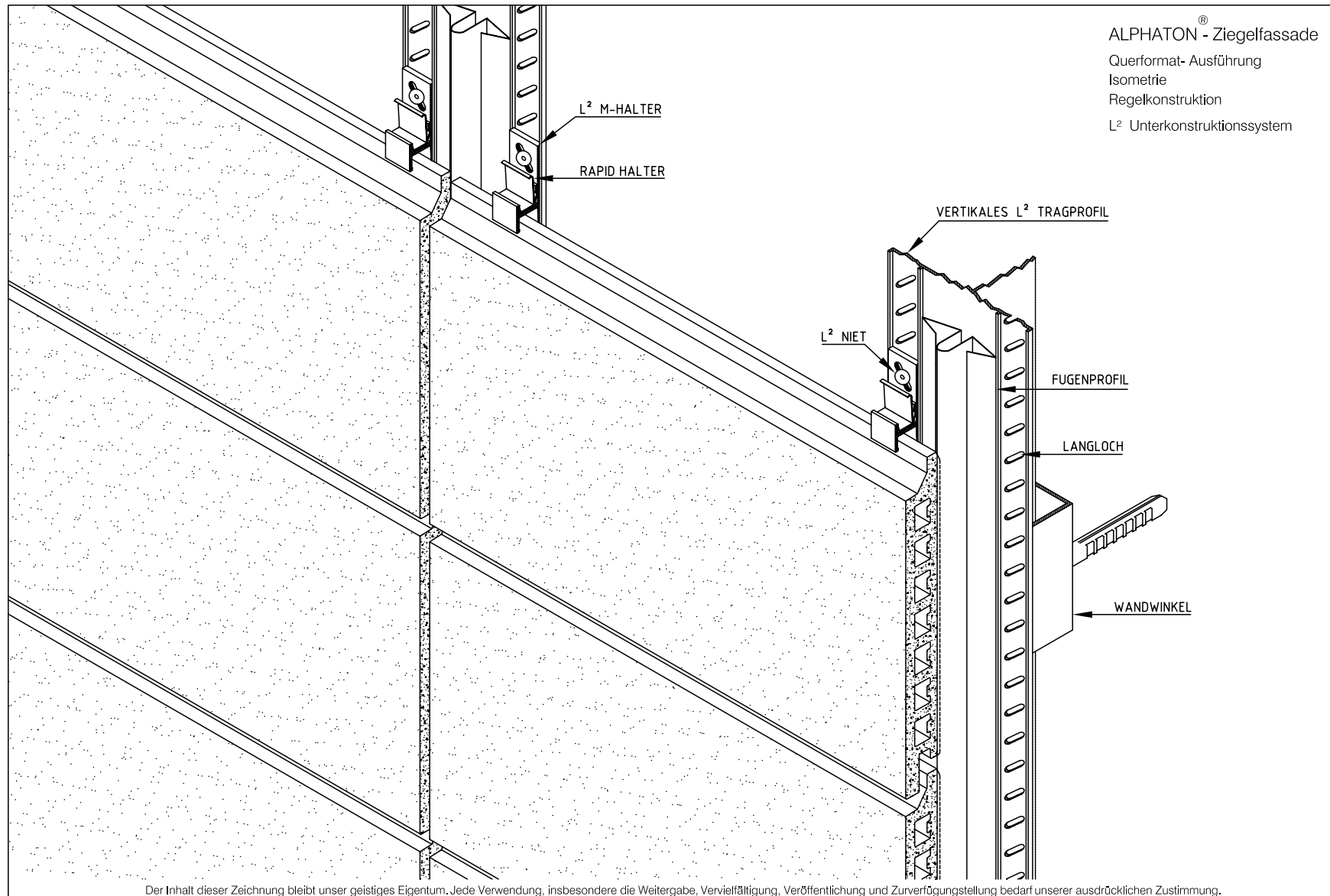

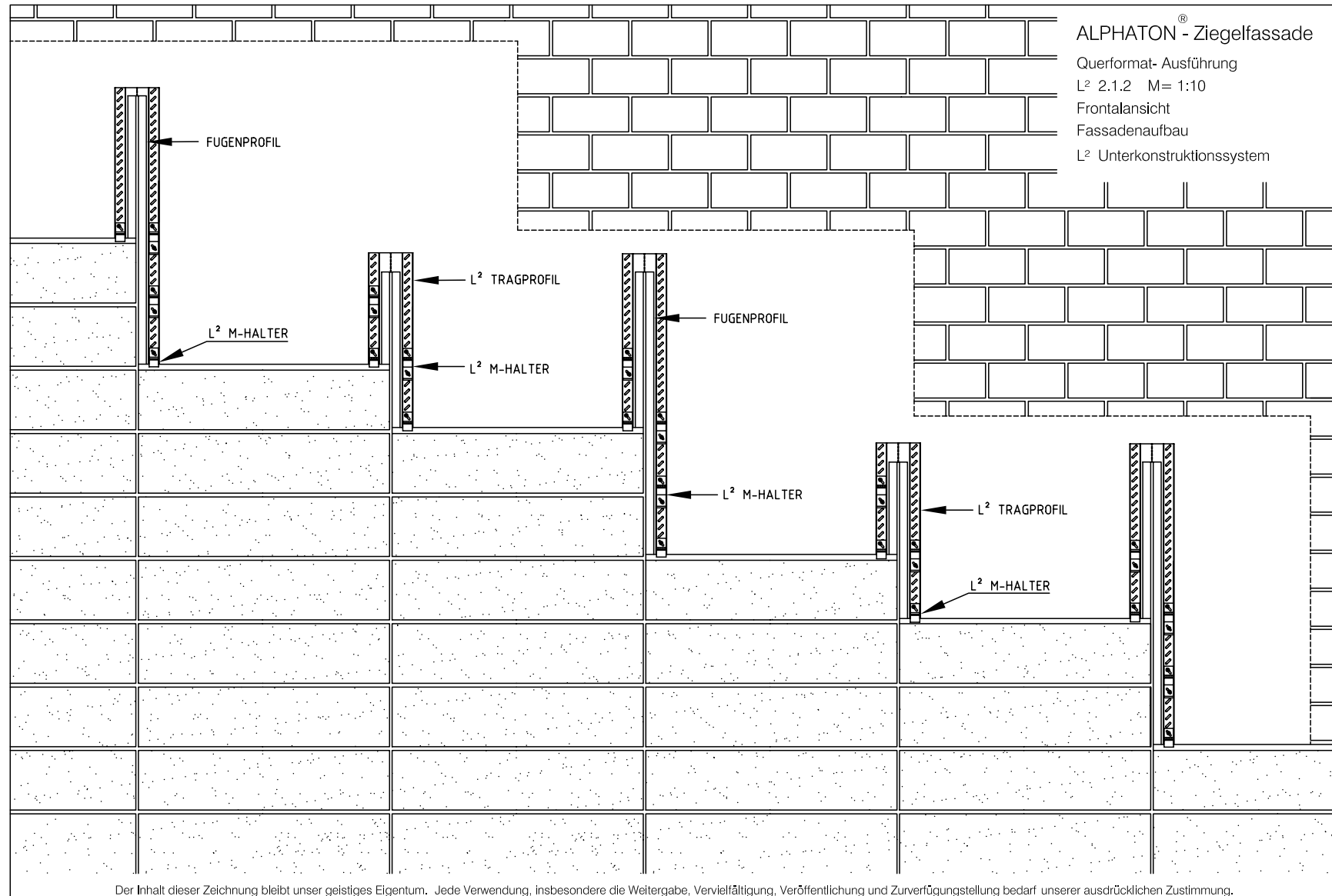

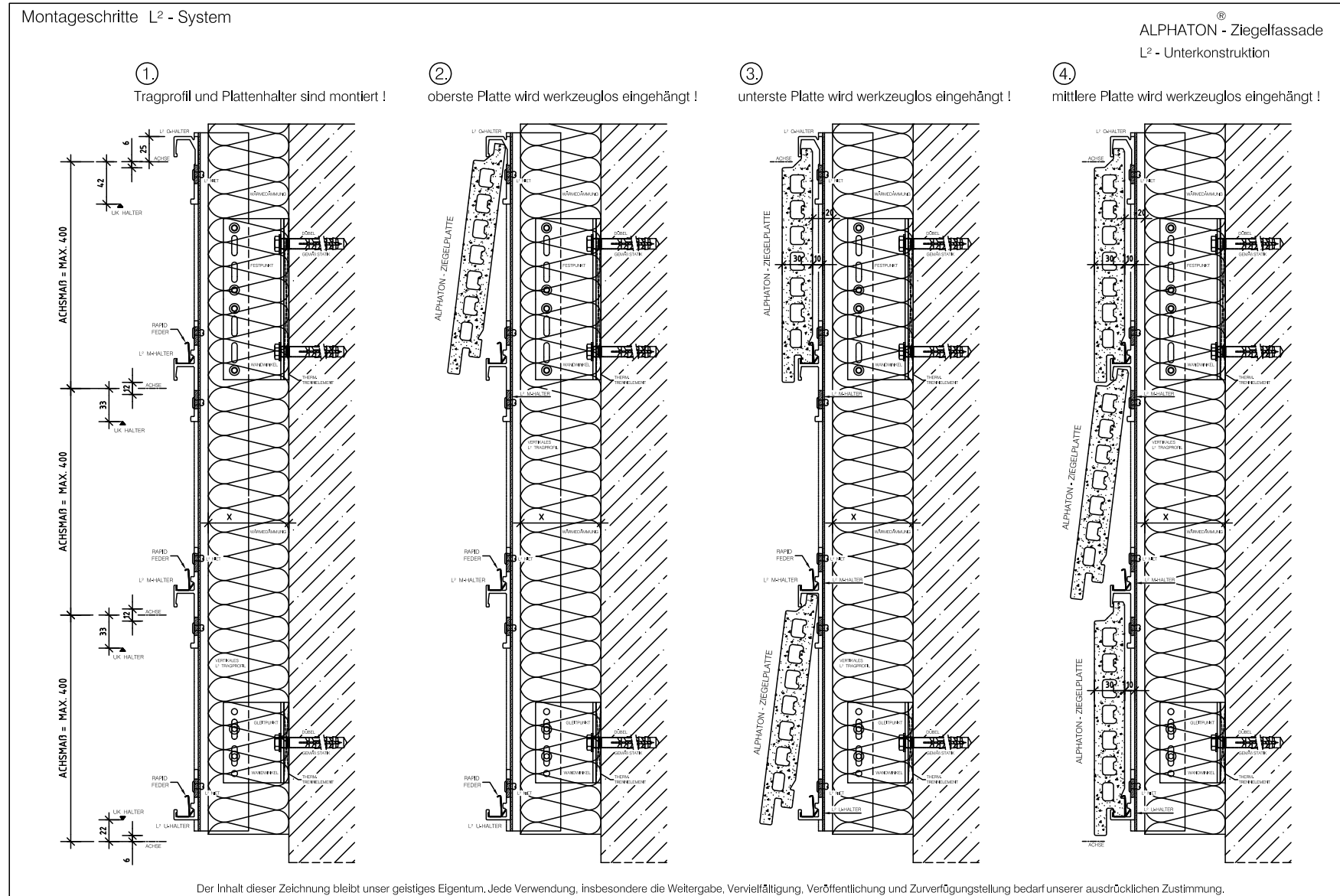

ALPHATON® auf Alu-Unterkonstruktion L²
 ALPHATON® on L² aluminium substructure
 ALPHATON® sur ossature en aluminium (L²)

Gesamtschnitt
 Overall section
 Vue en coupe (générale)

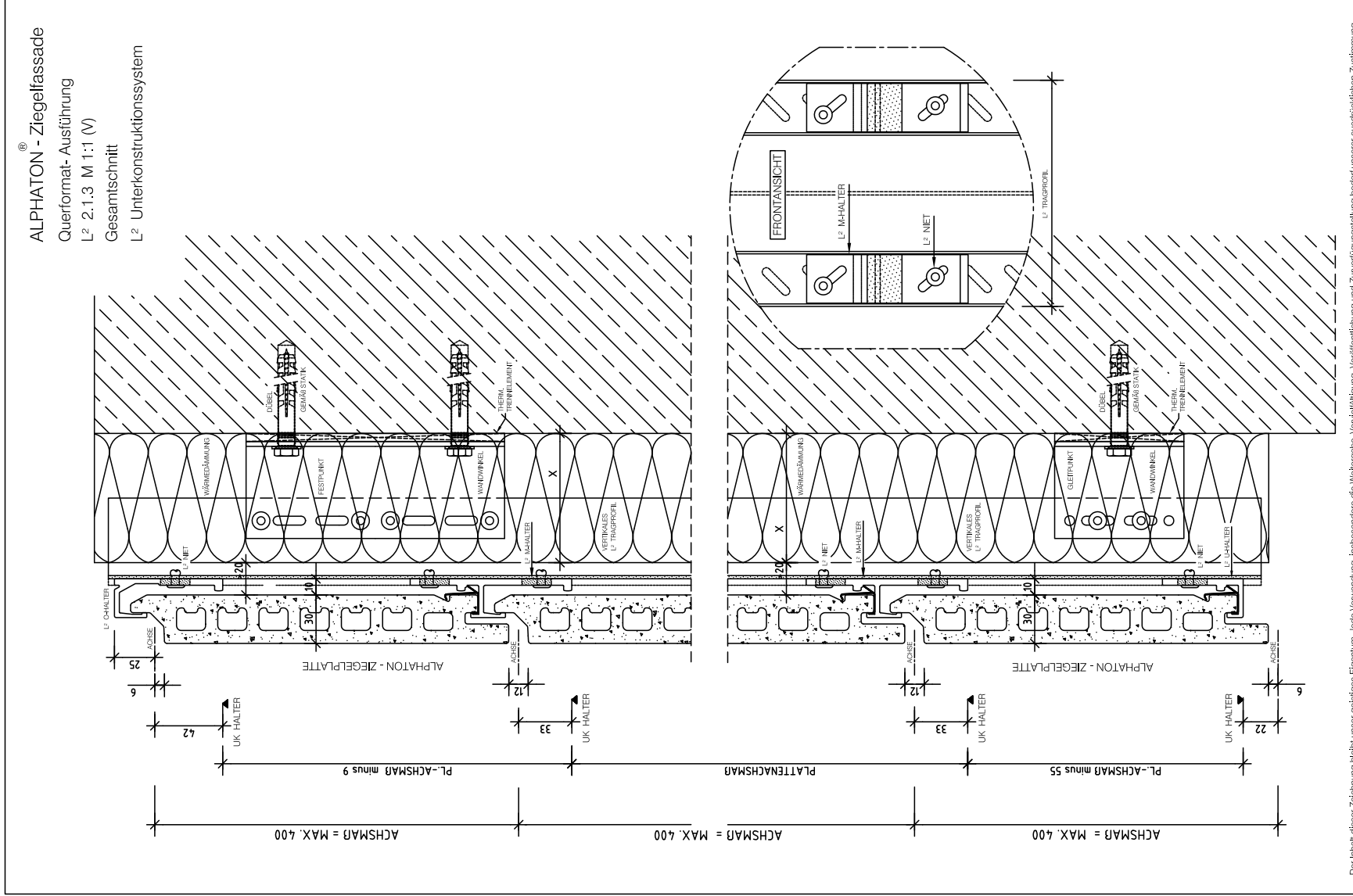

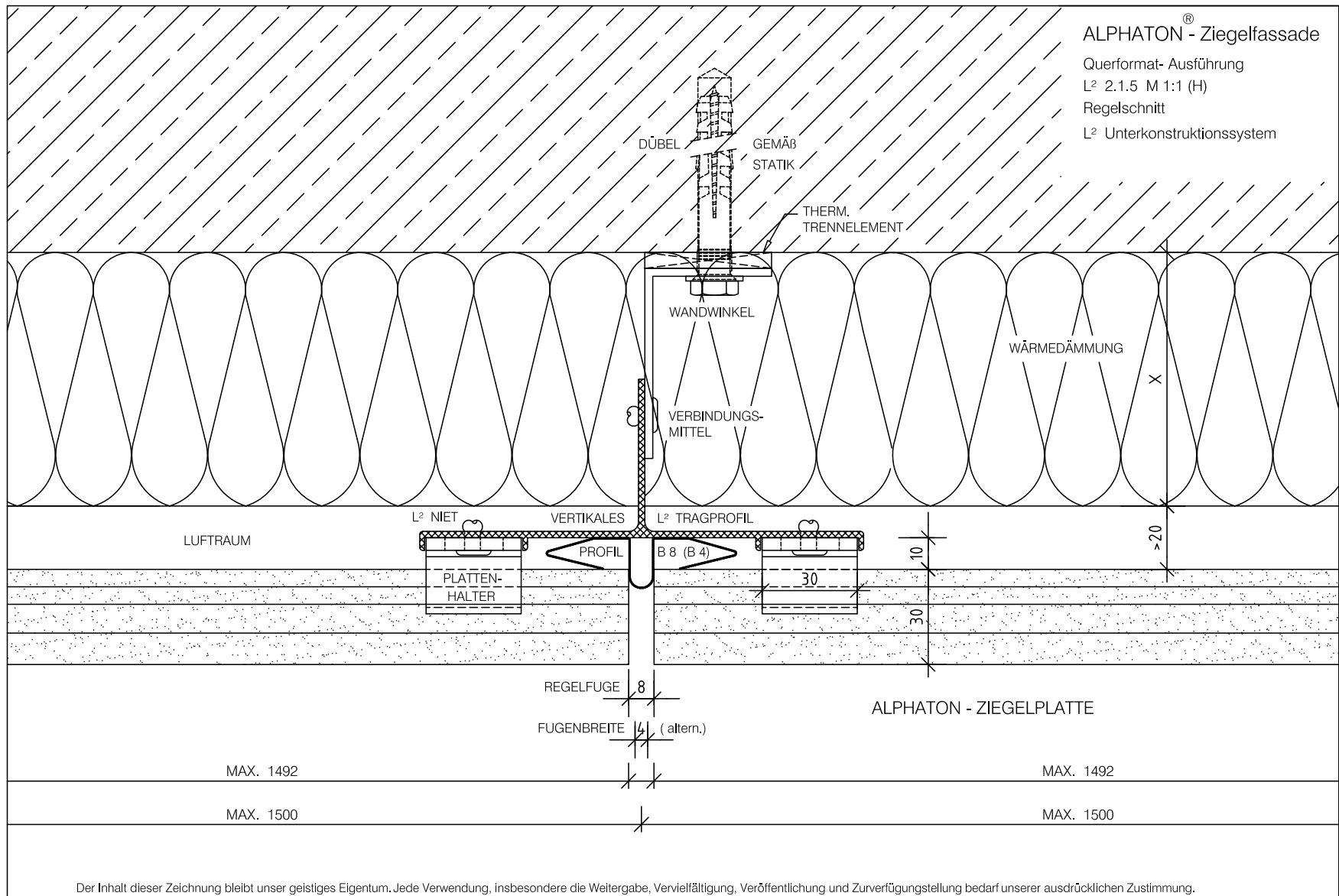

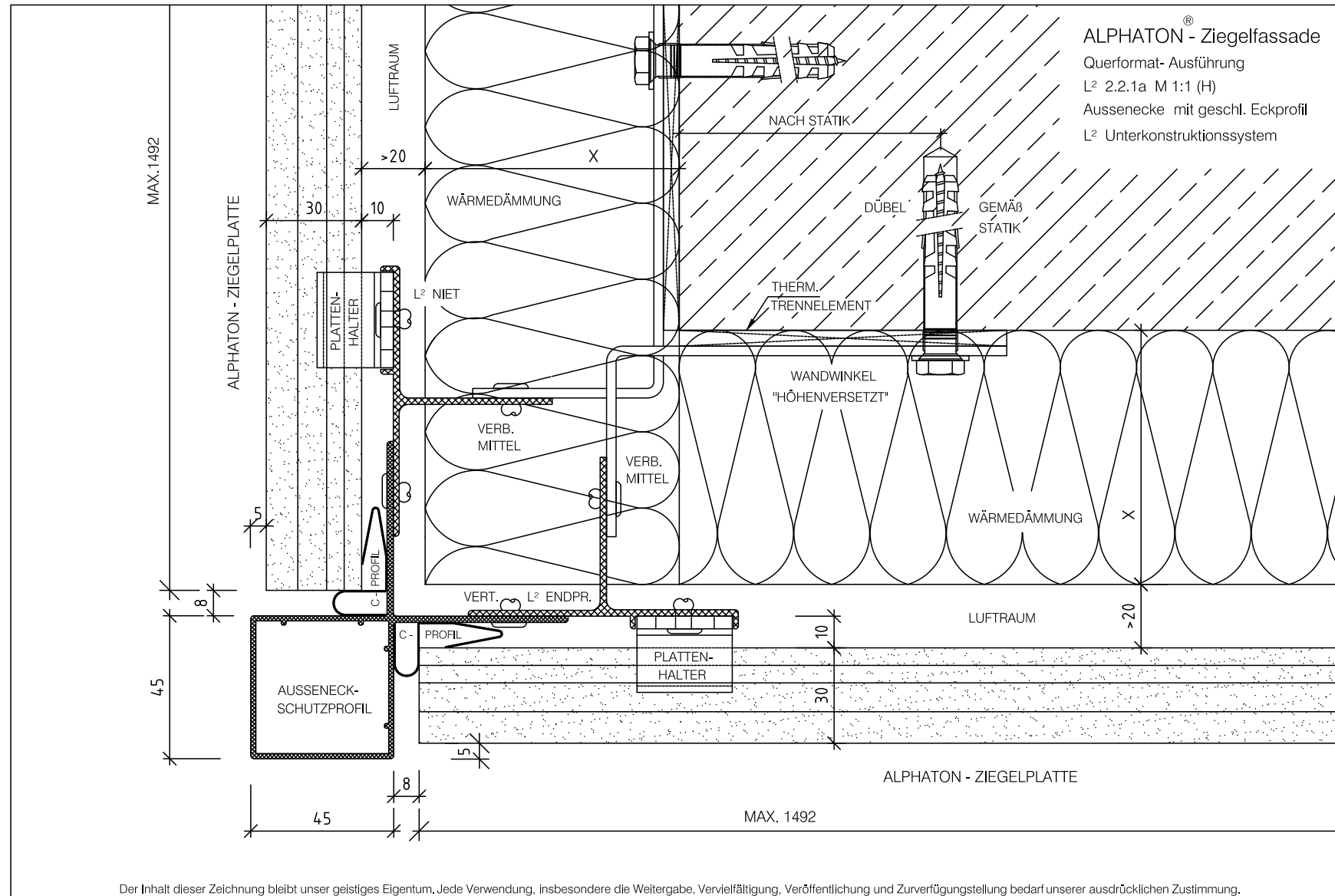

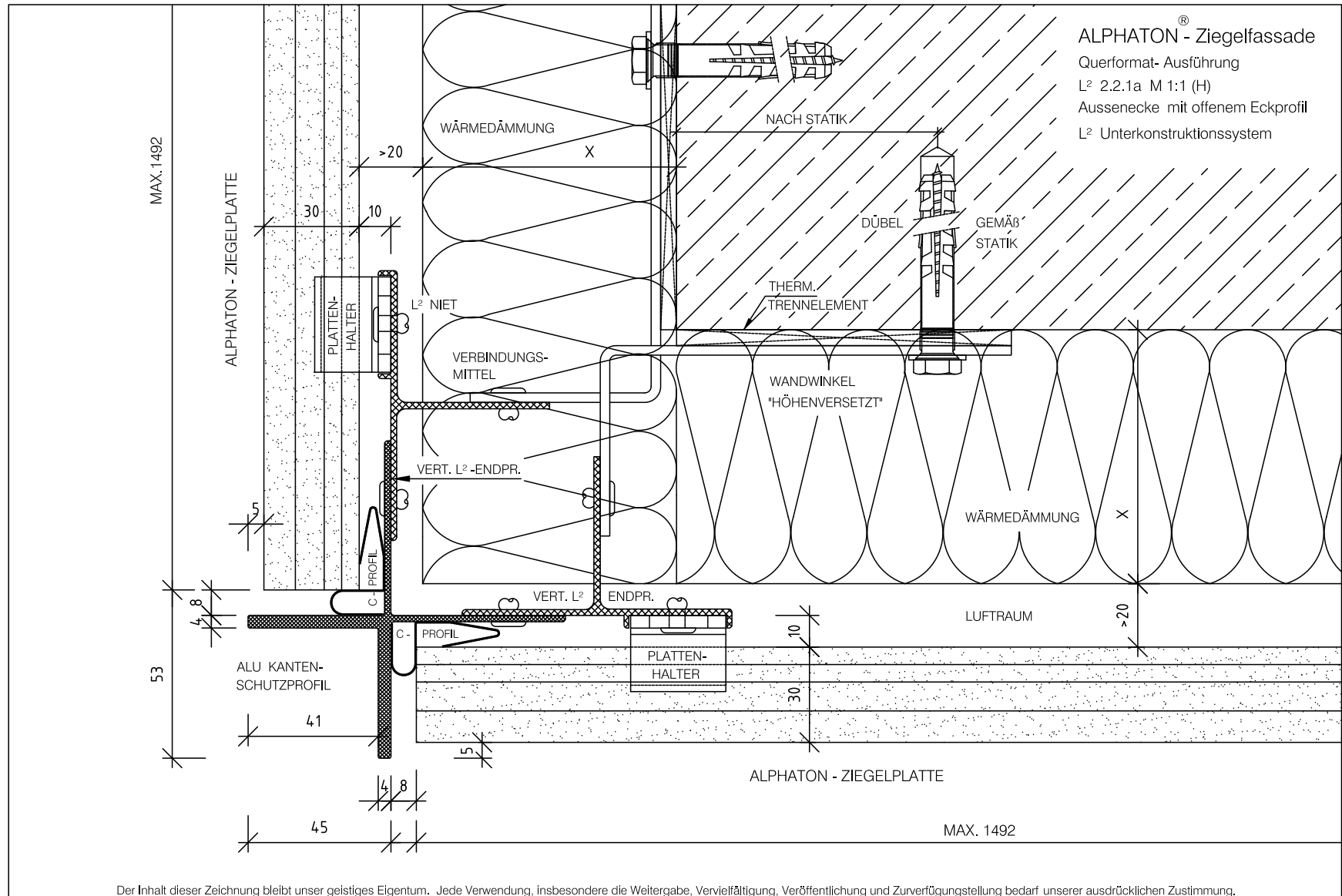

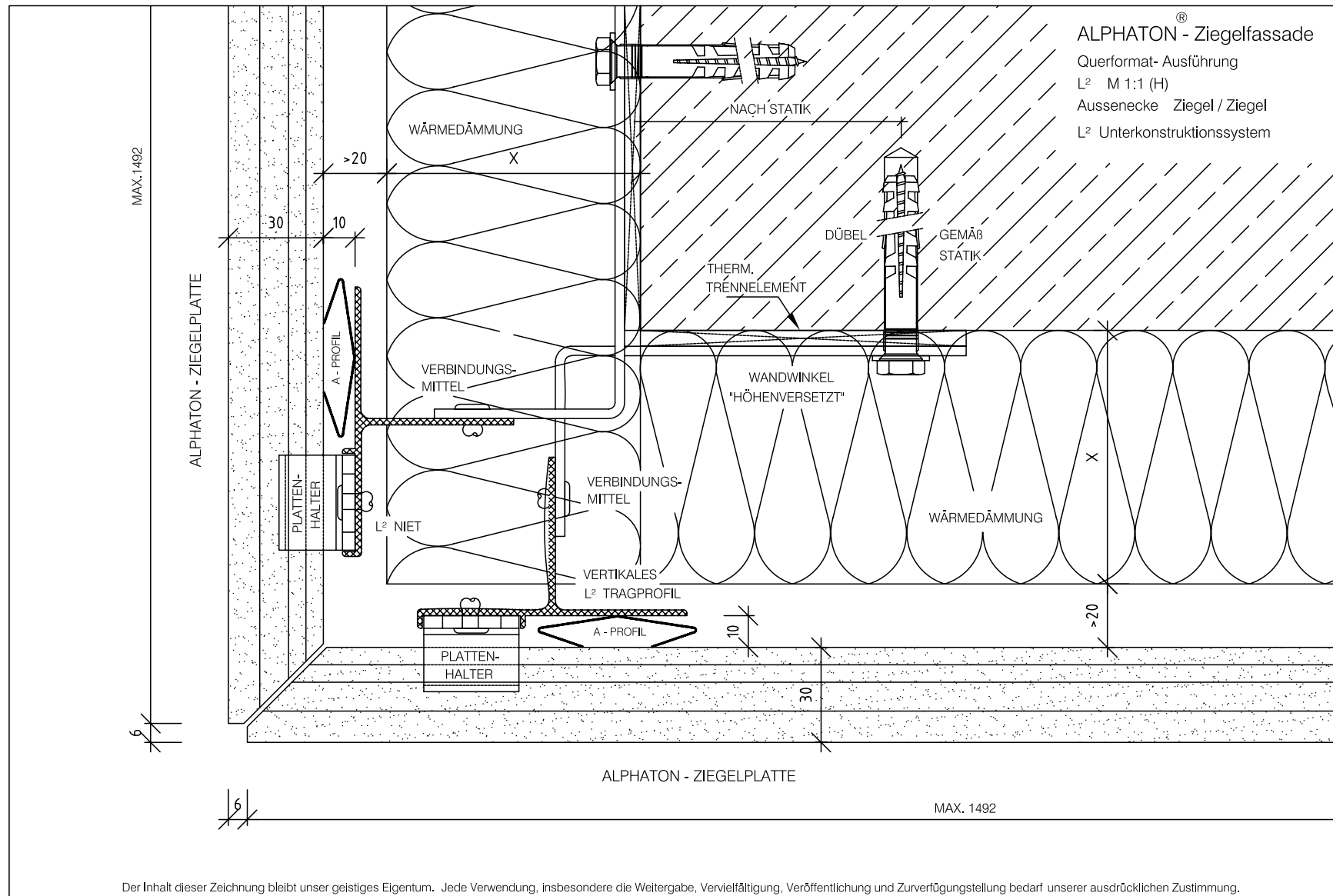

Giebelecke bündig
 Gabel corner, flush
 Coin - coupe à onglet

ALPHATON® auf Alu-Unterkonstruktion L²
 ALPHATON® on L² aluminium substructure
 ALPHATON® sur ossature en aluminium (L²)

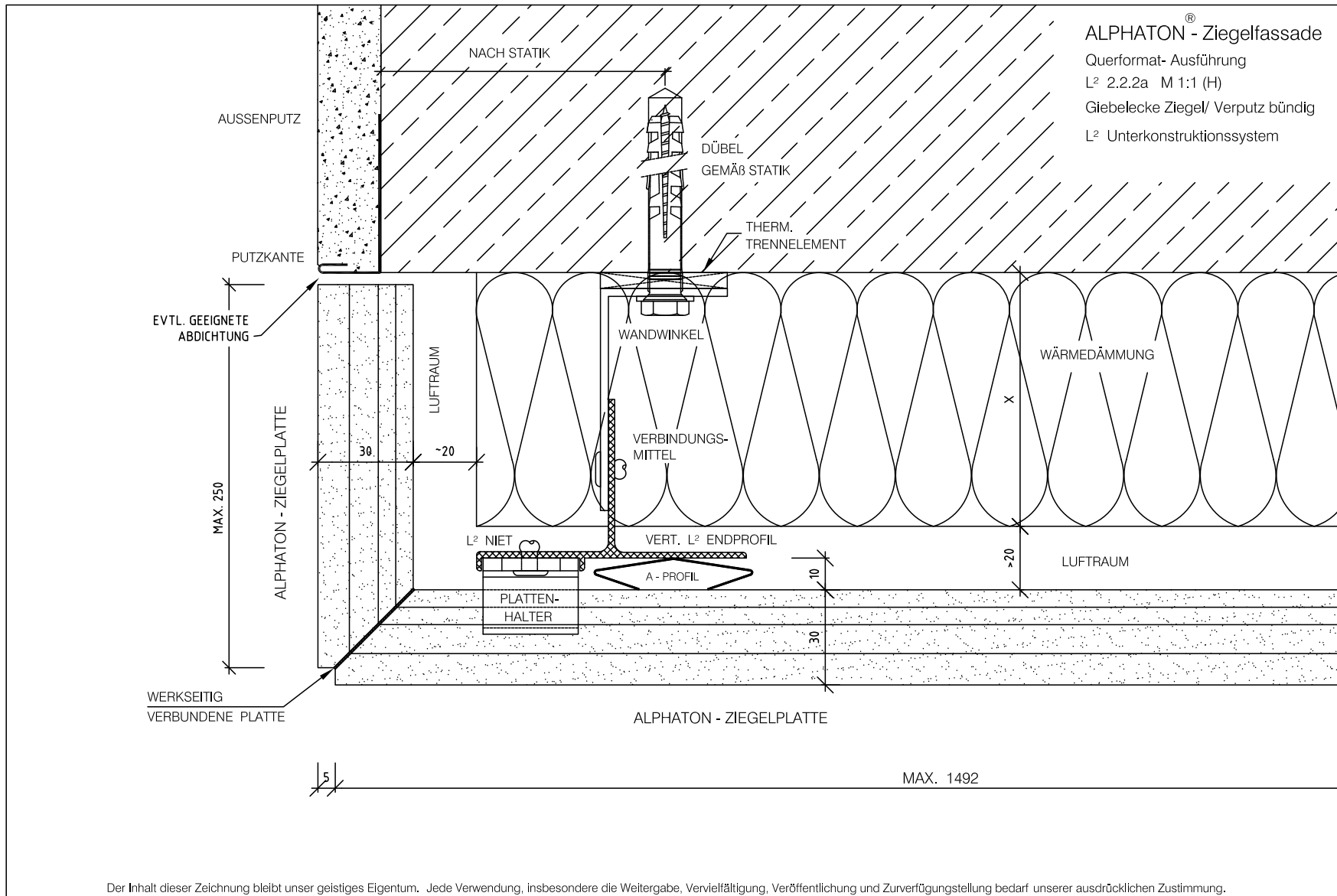

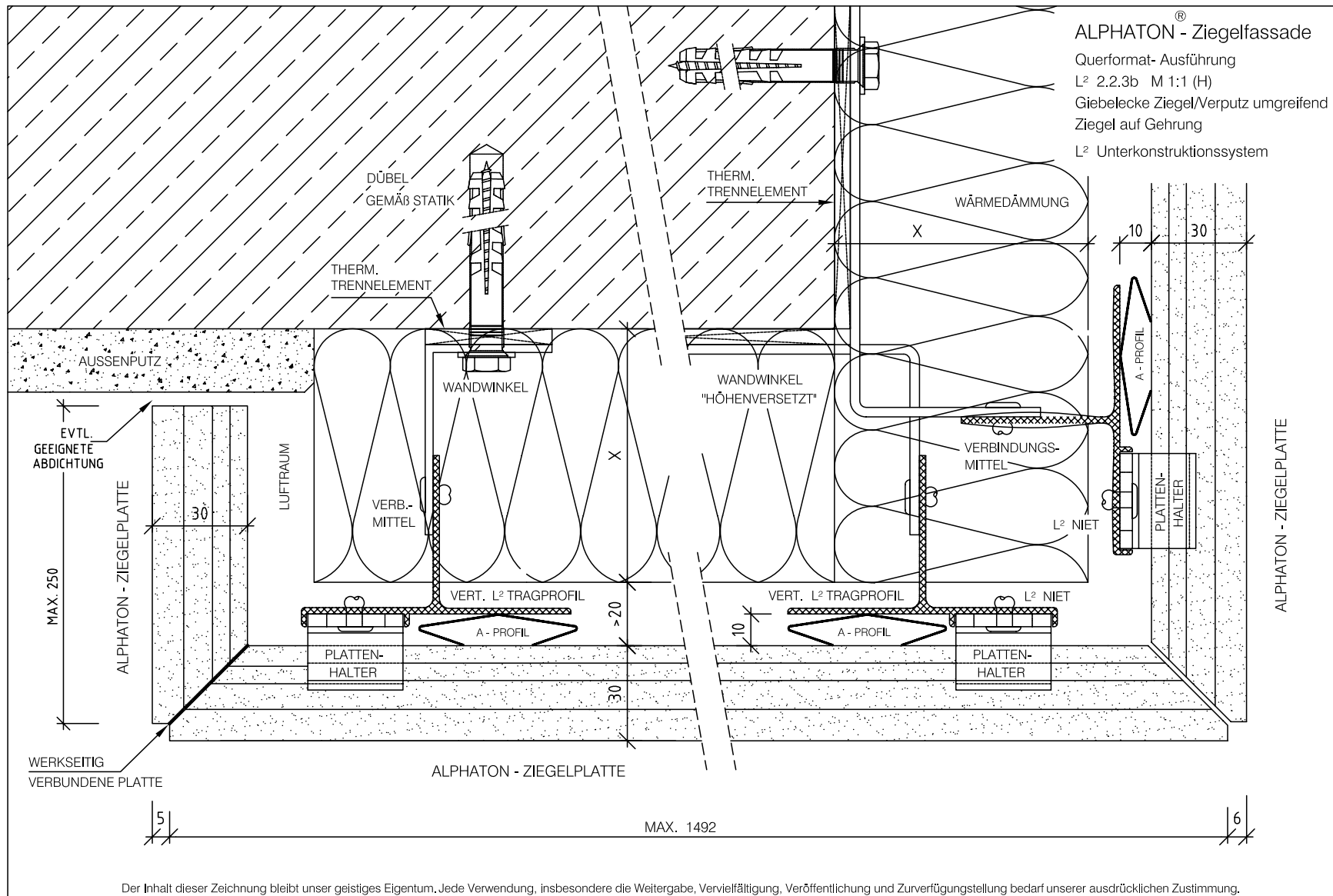

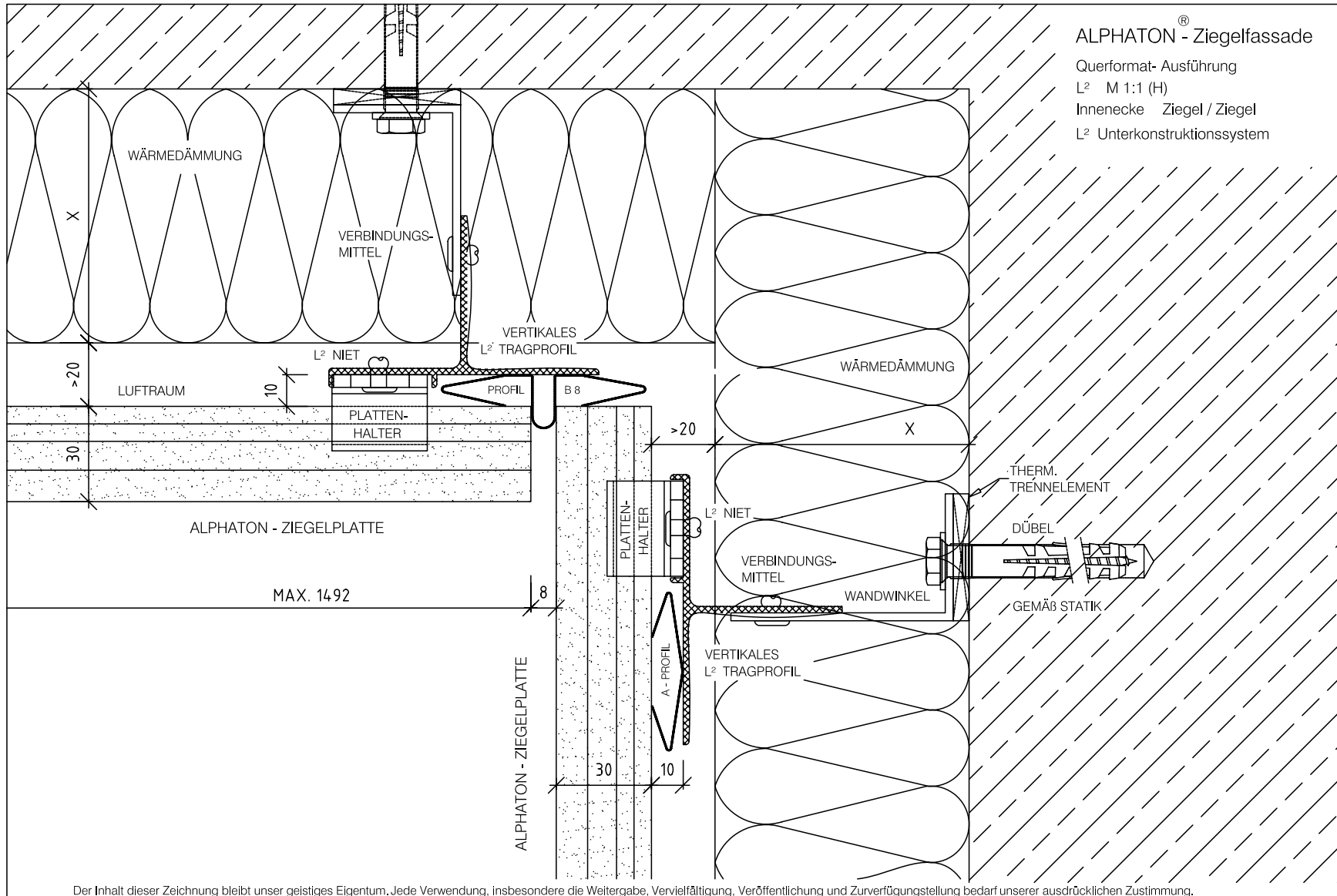

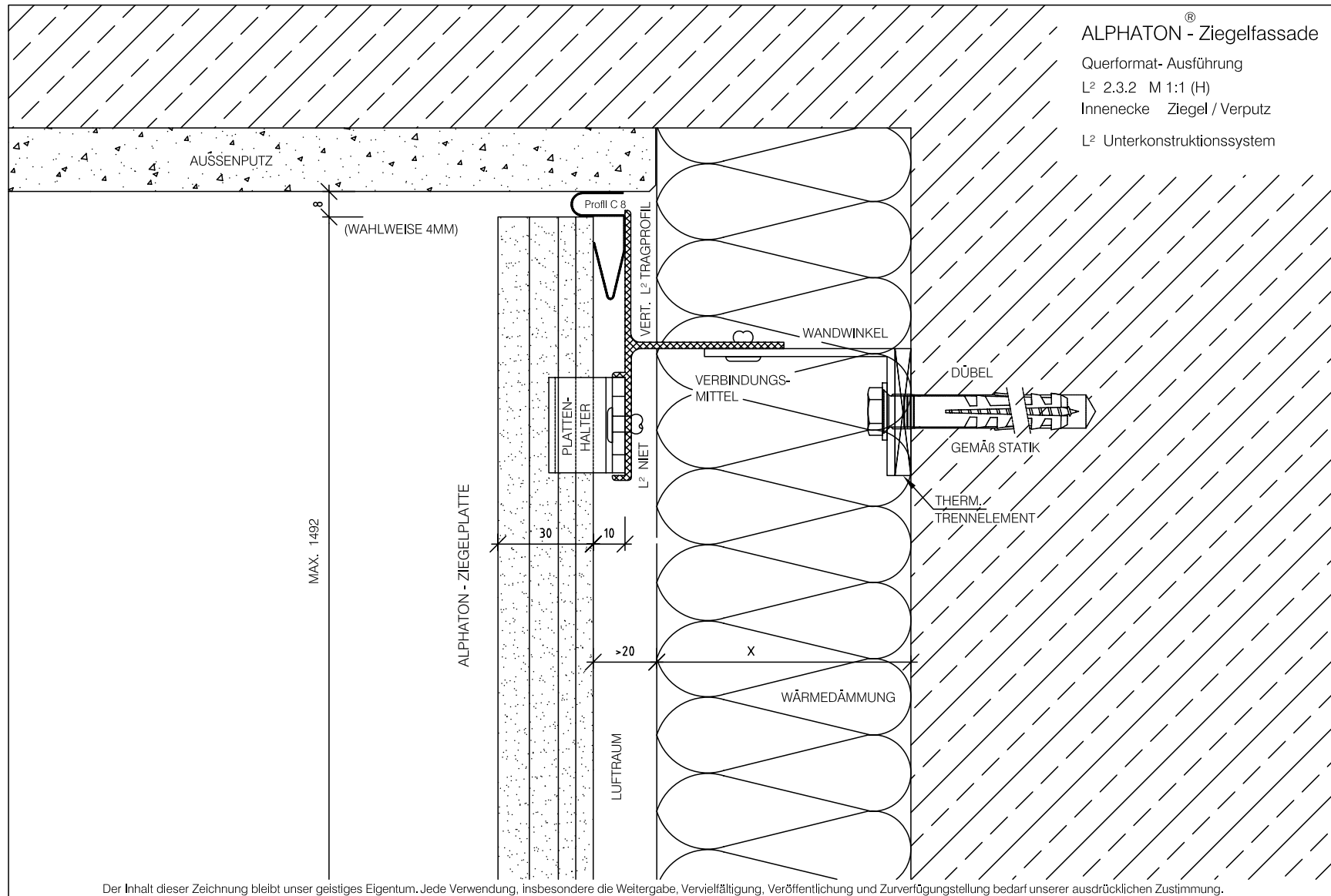

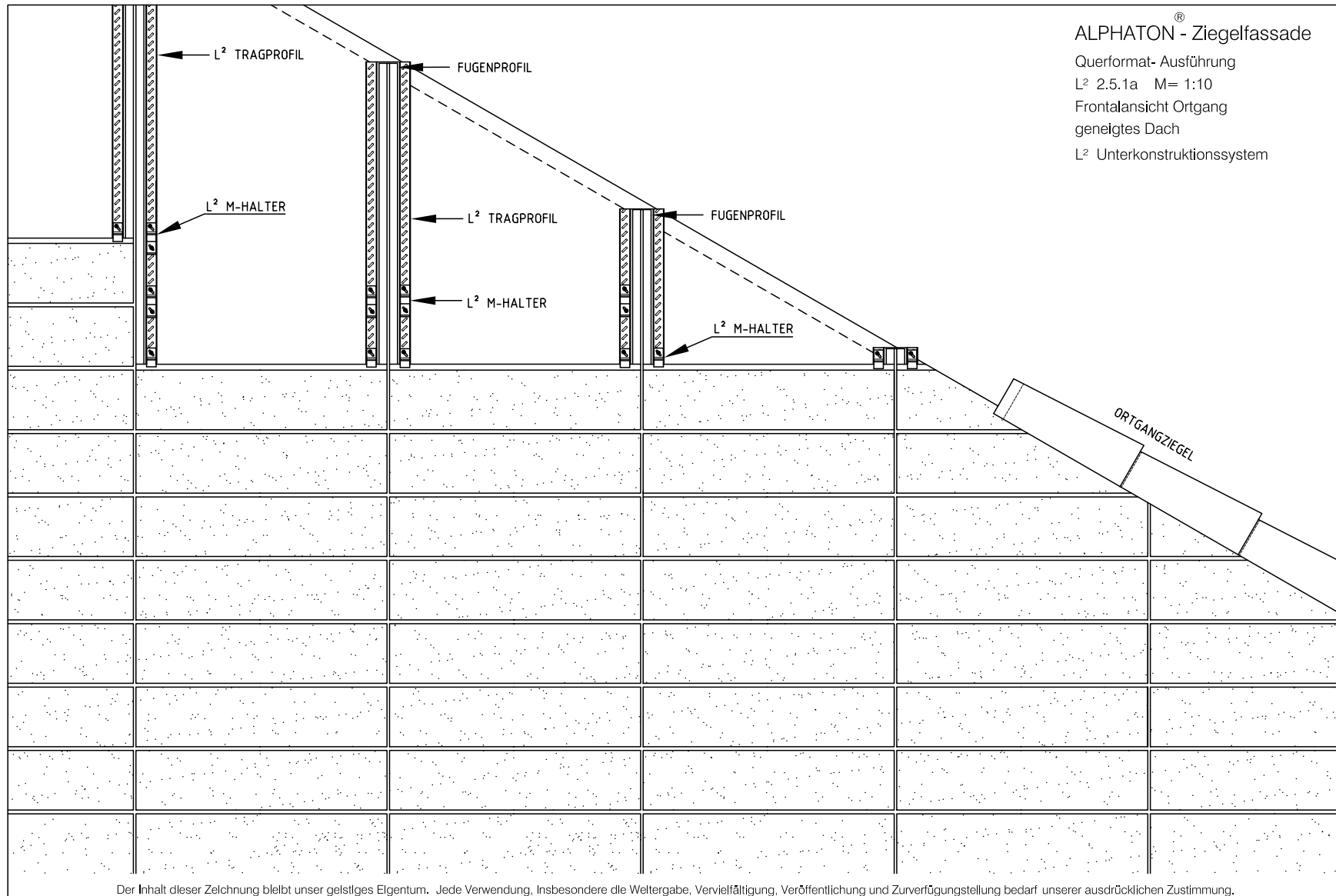

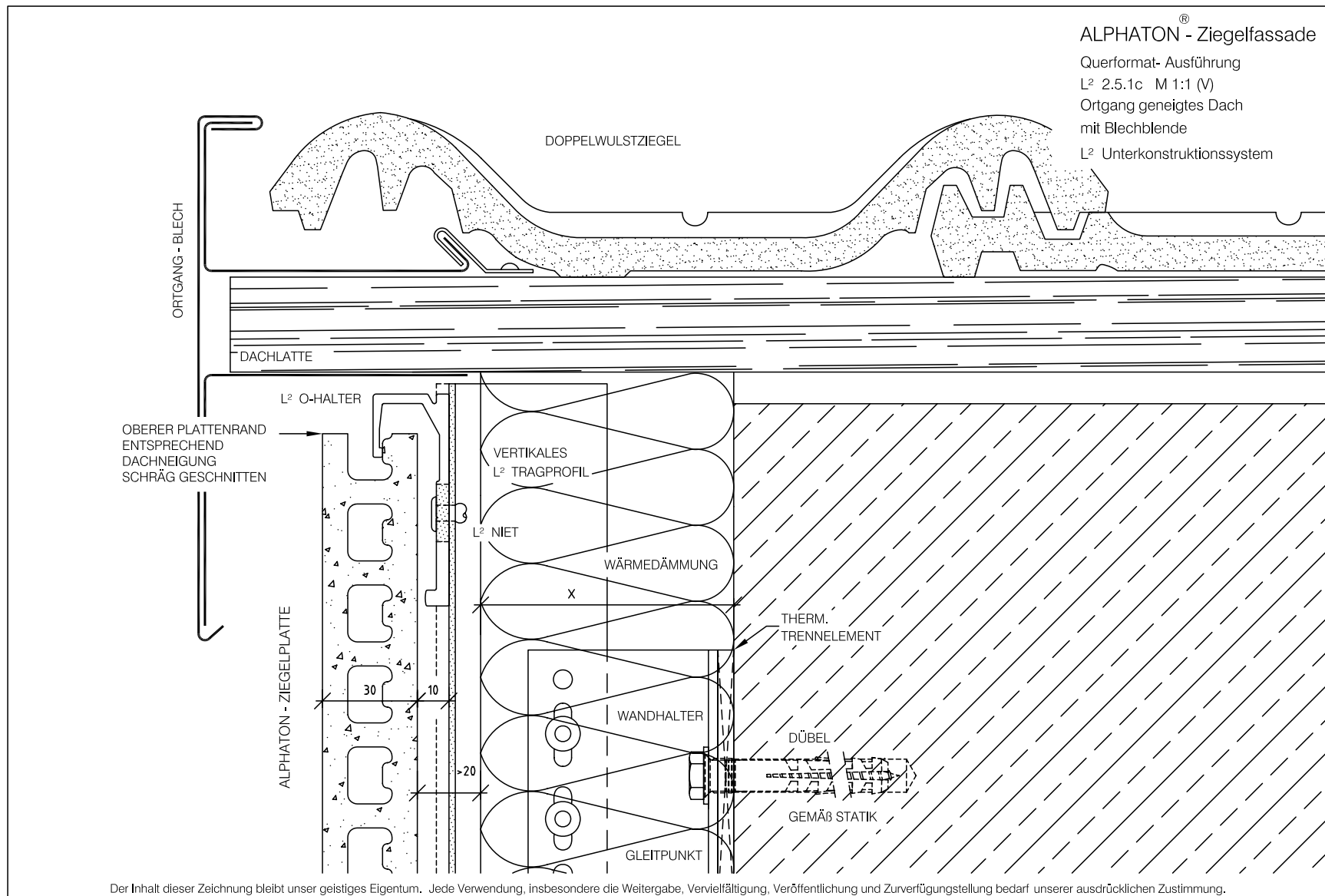

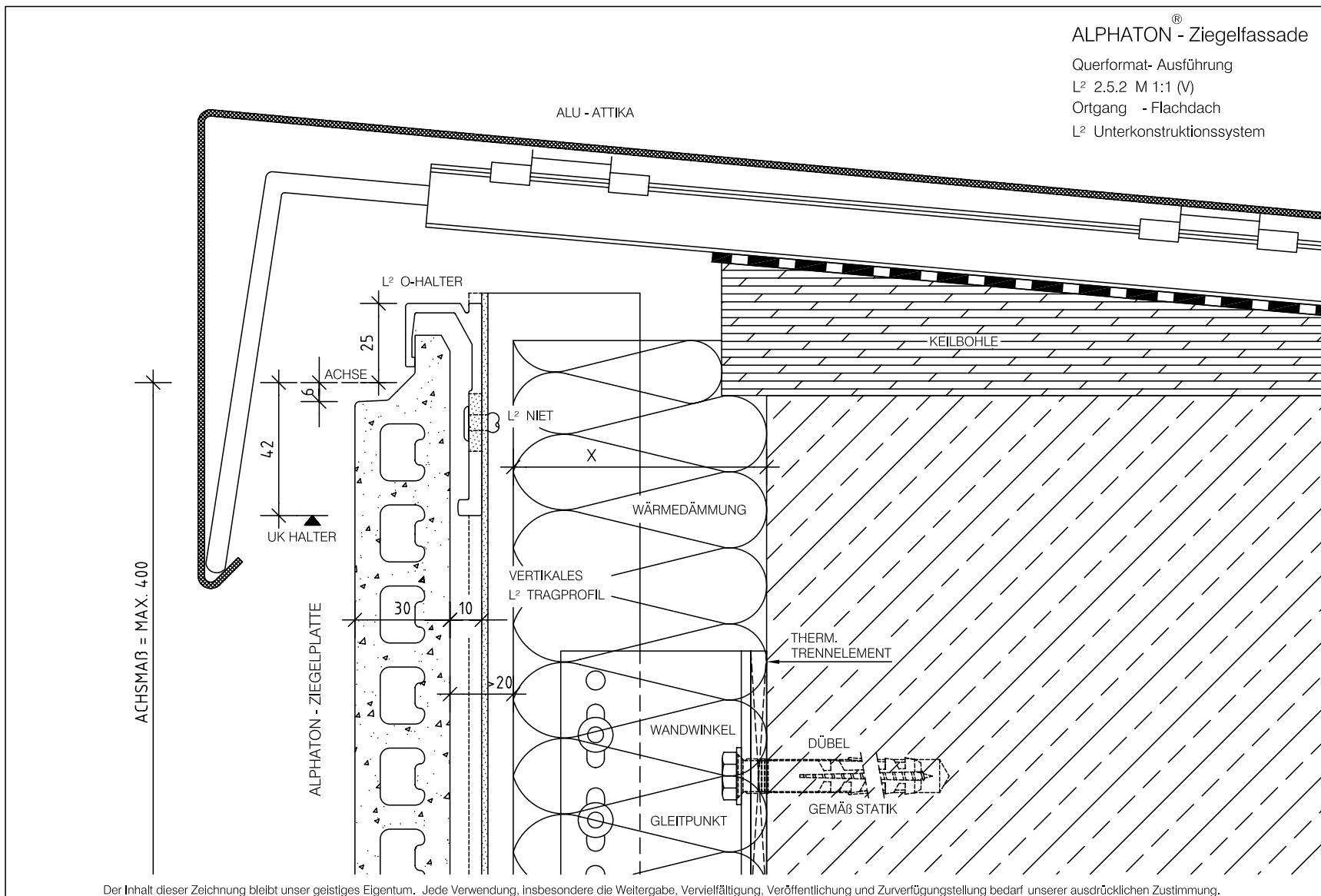

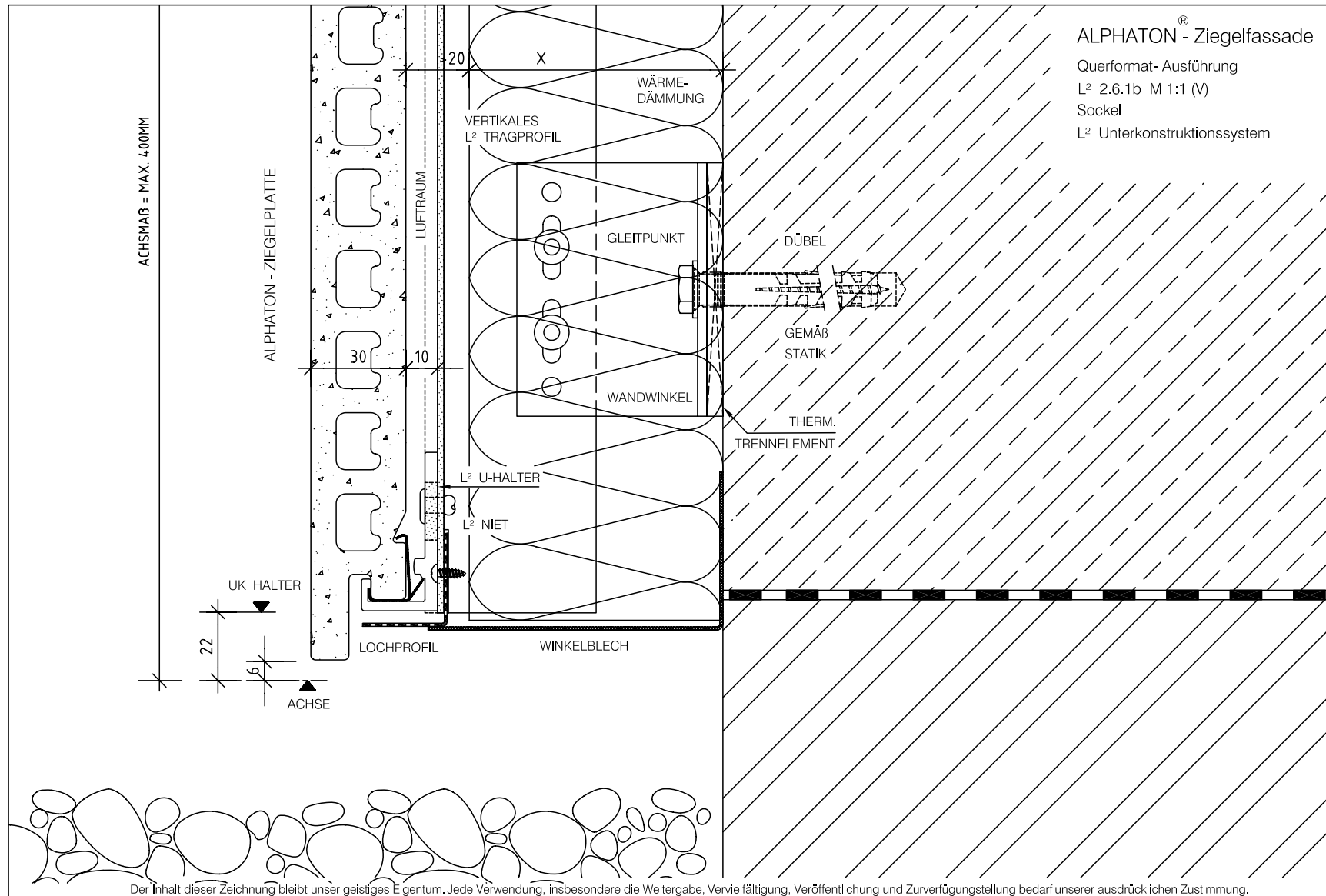

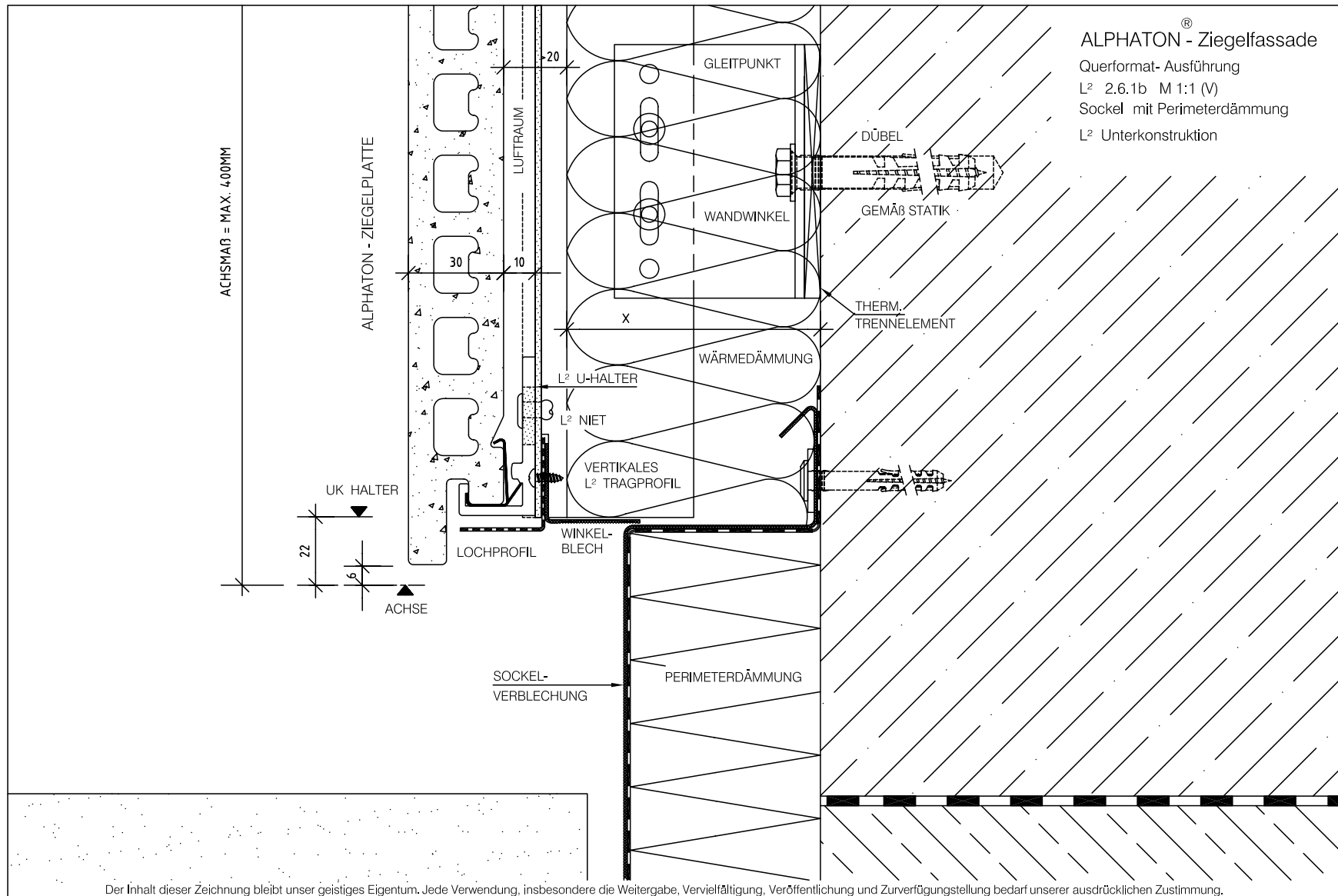

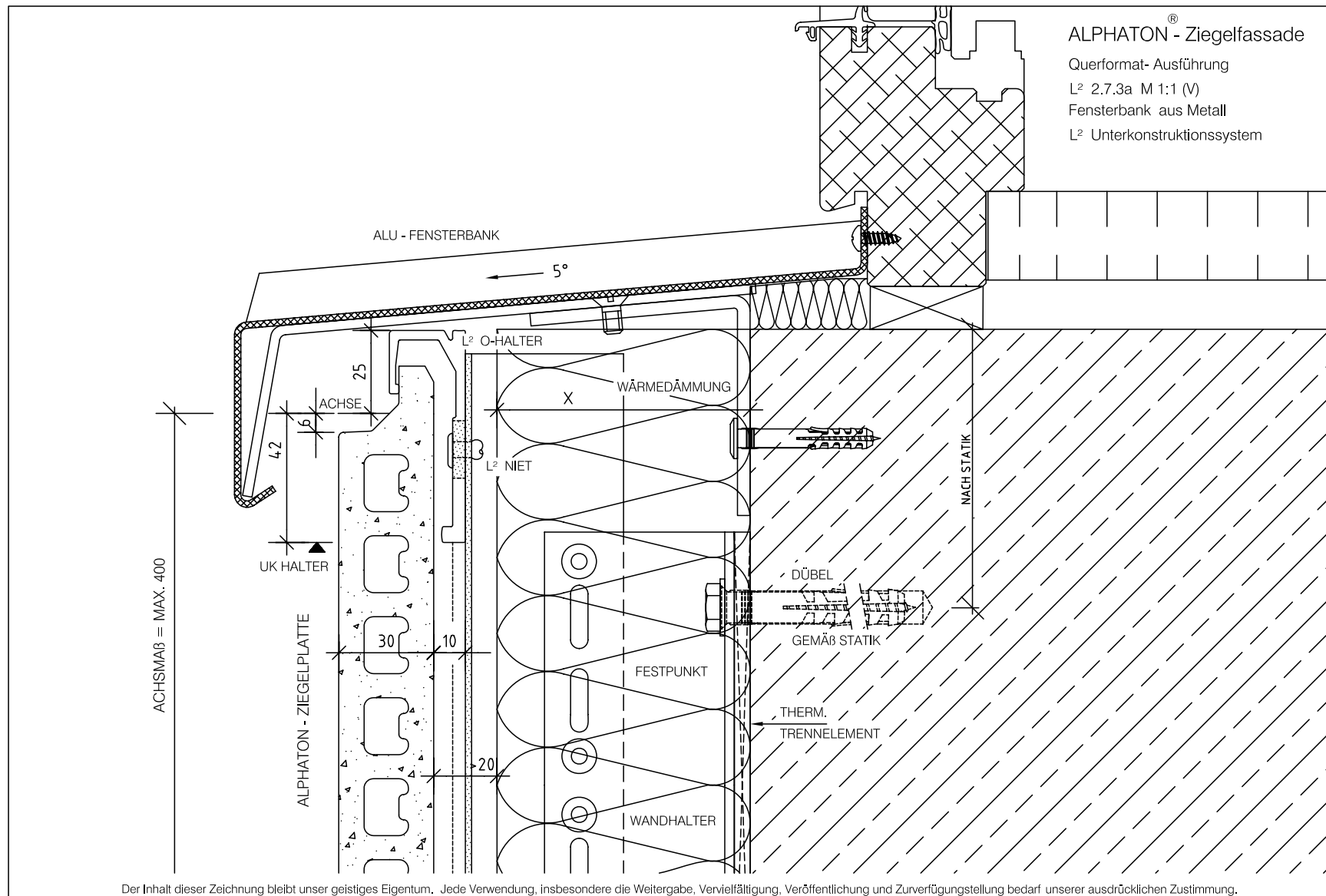

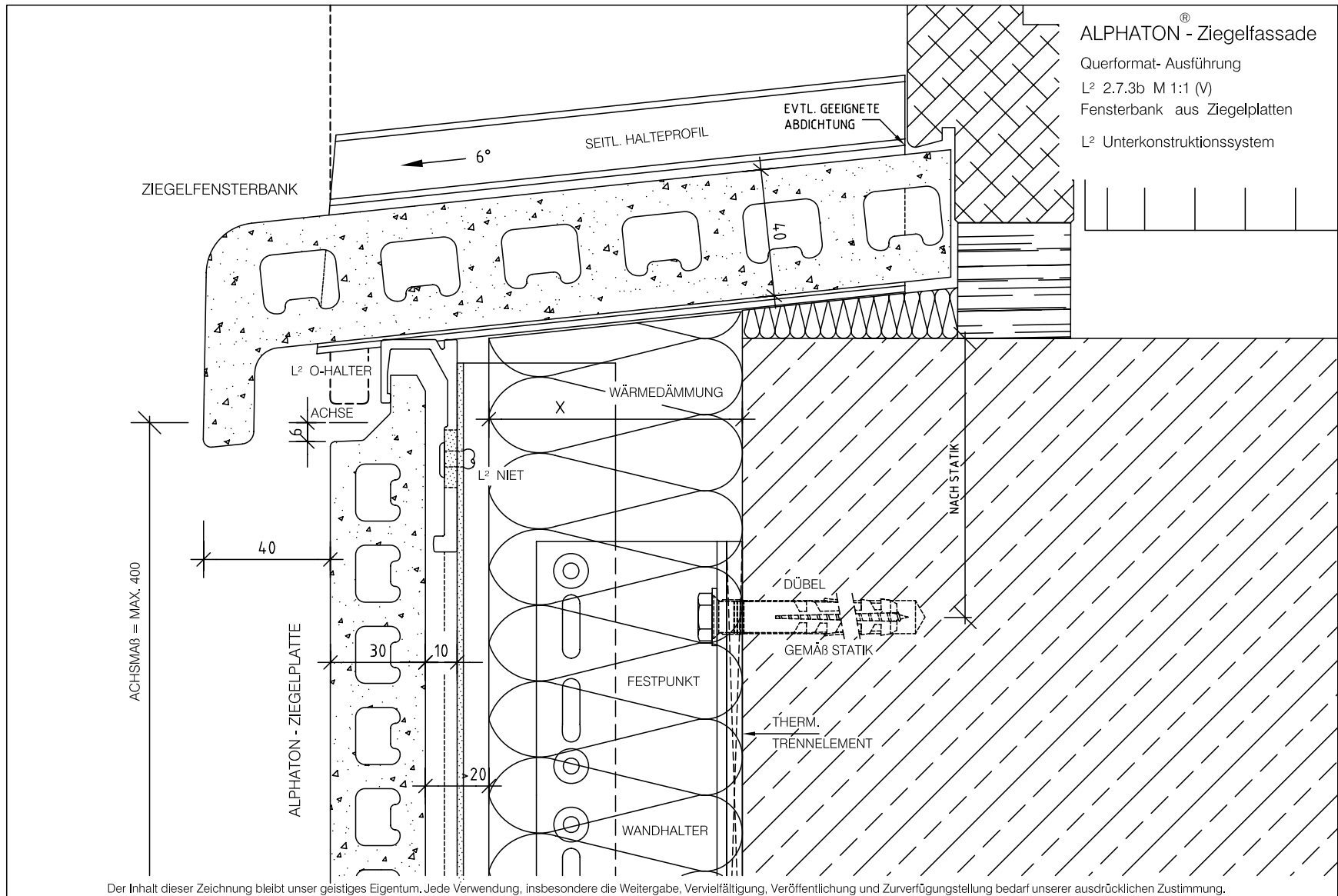

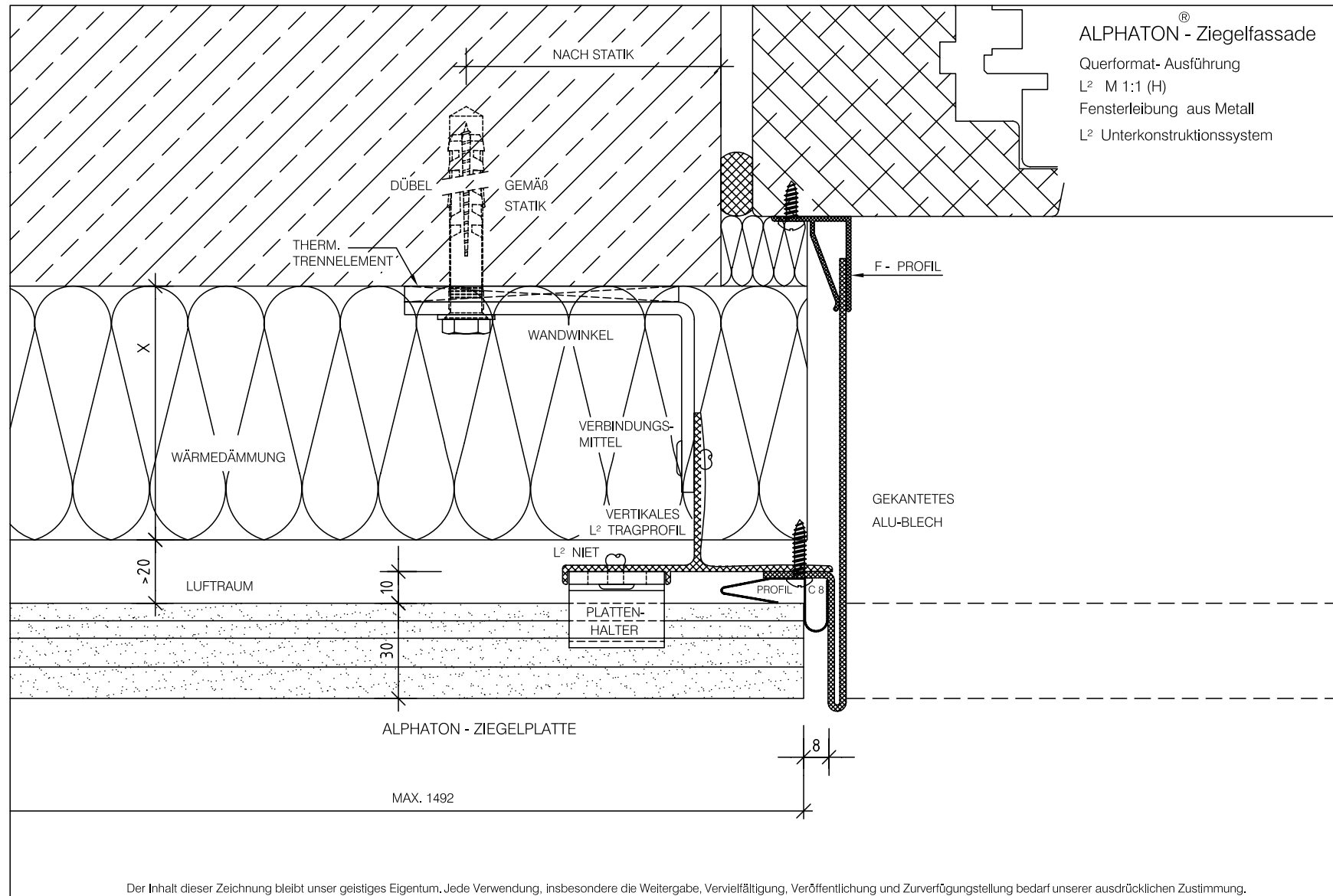

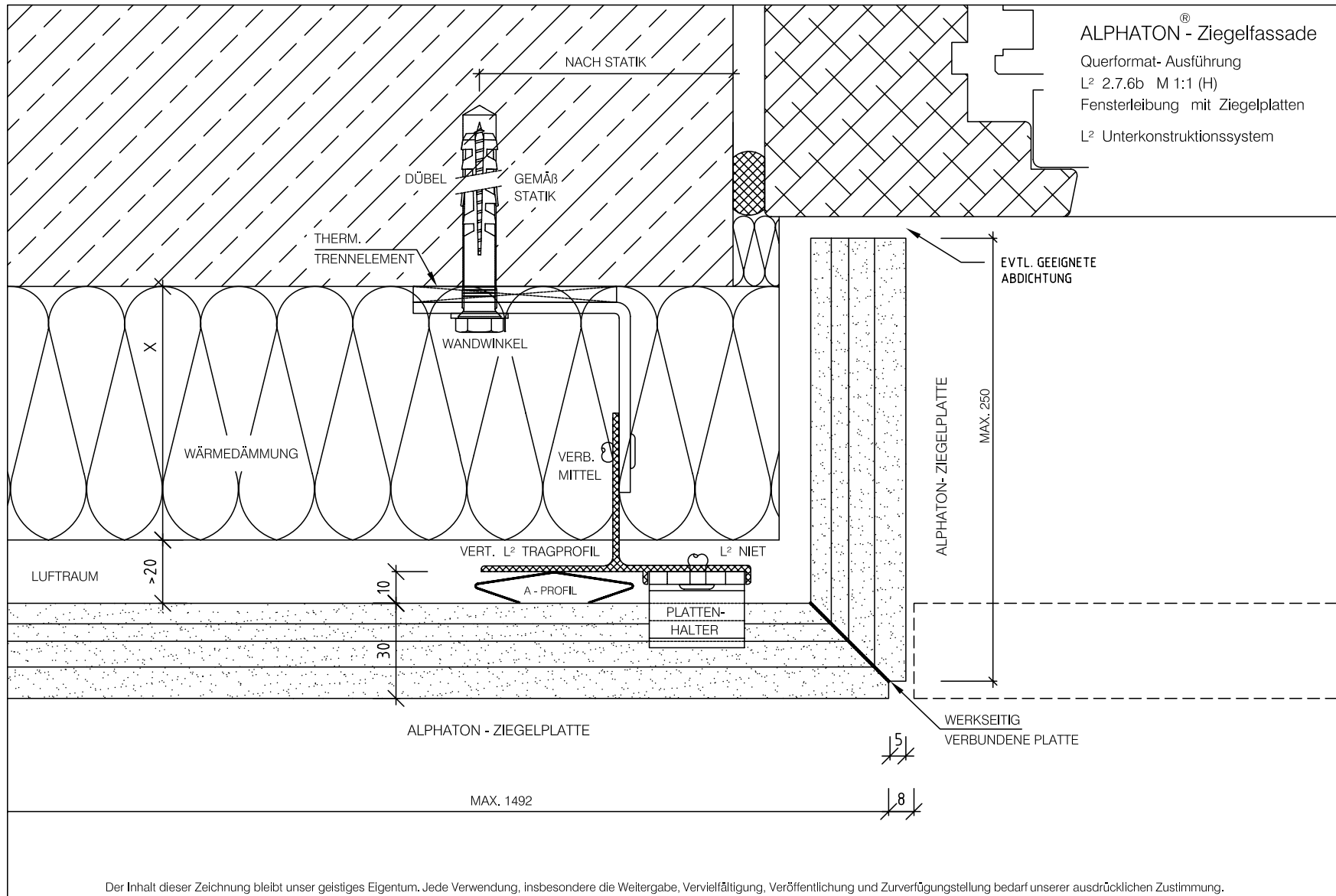

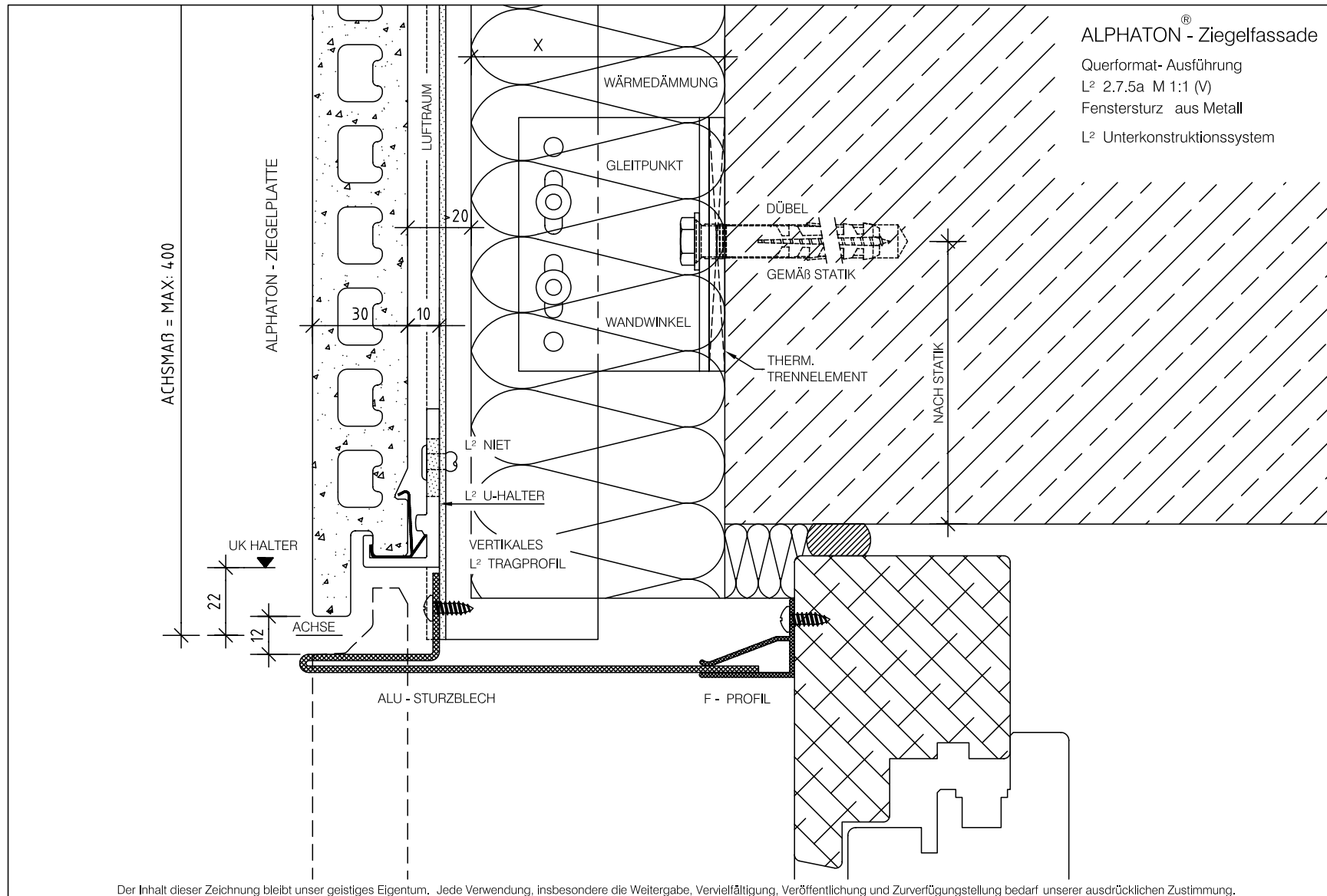

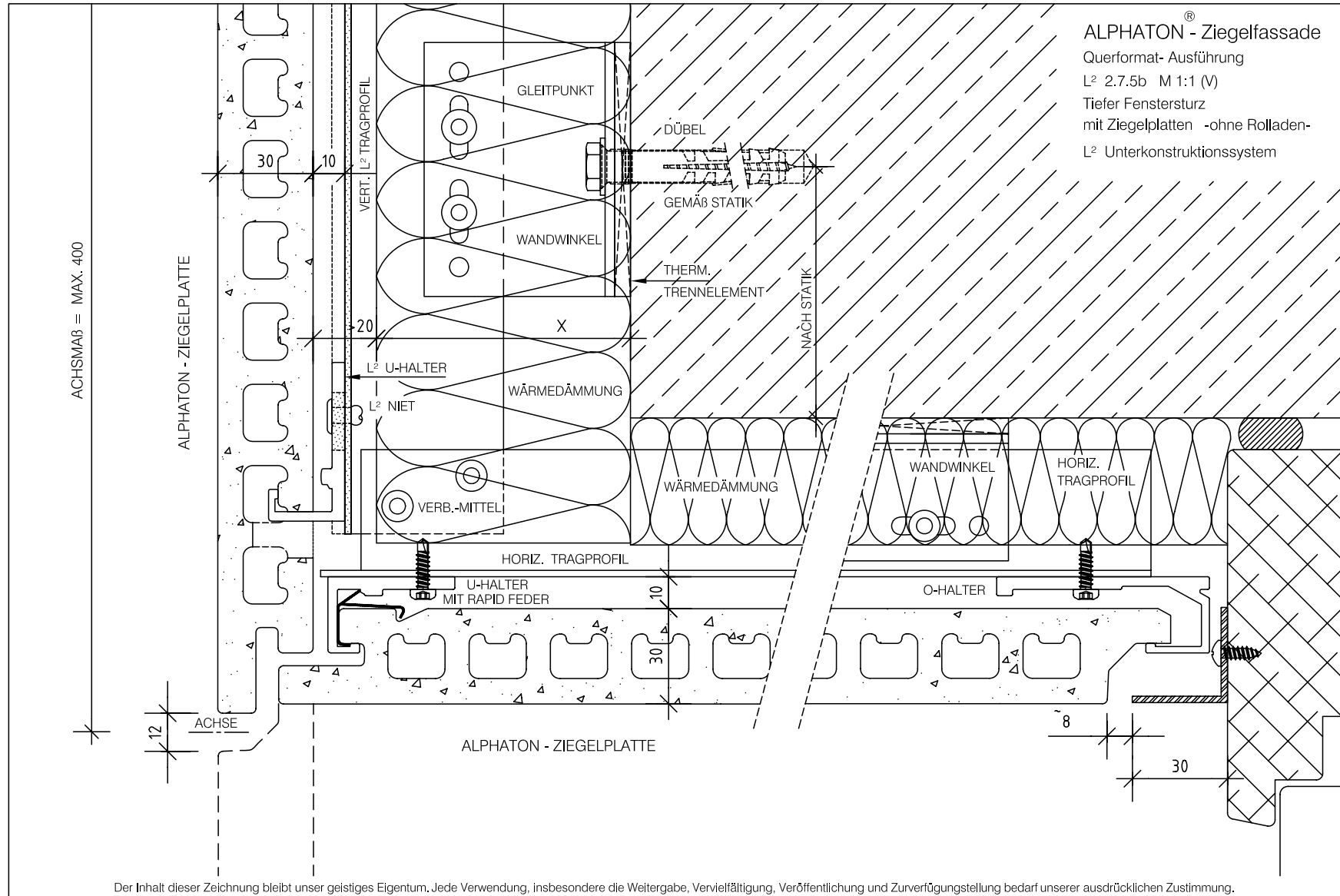

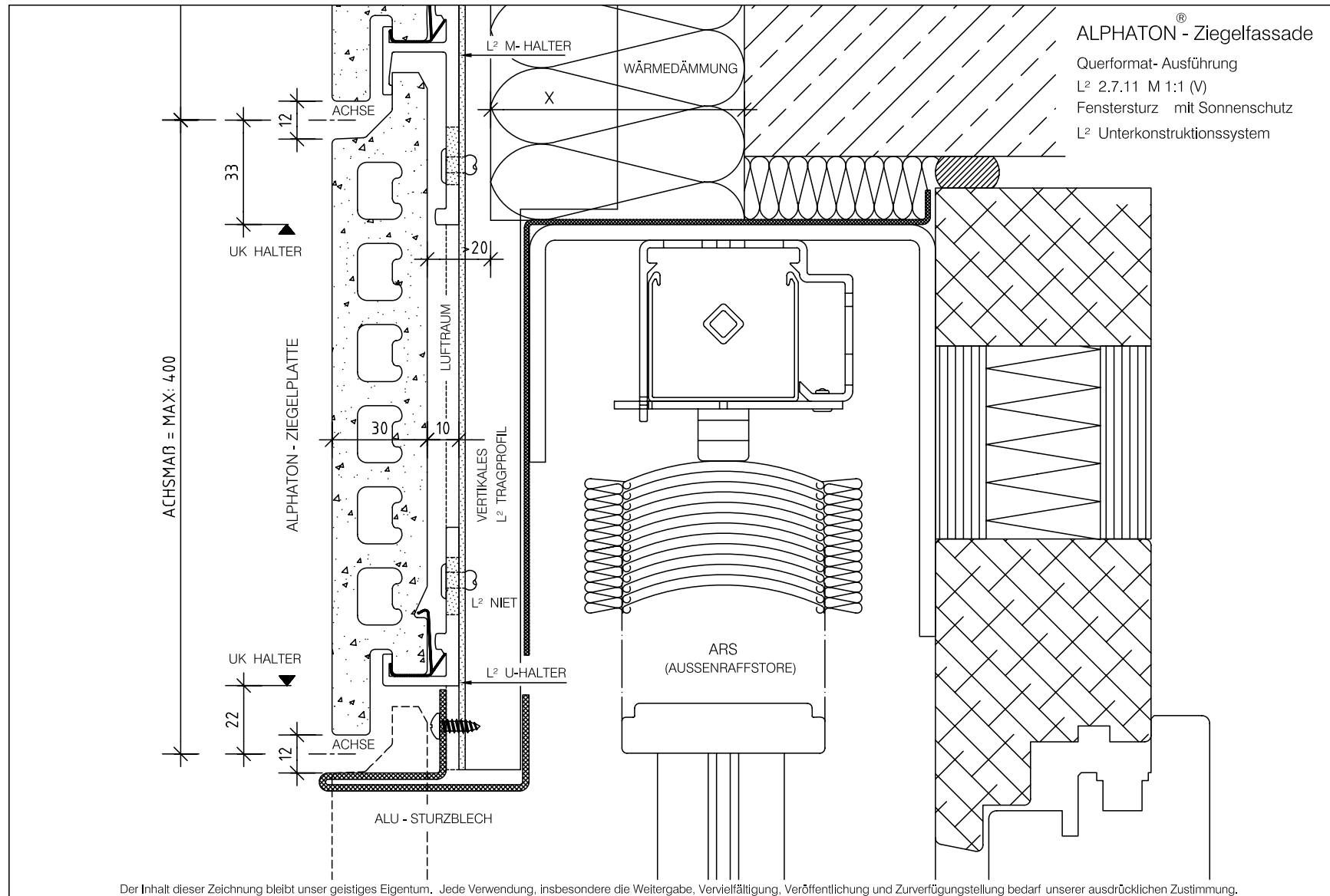

Fallrohre in der Fläche
 Downpipes integrated in the façade
 Accents verticaux intégrés à la façade

ALPHATON® auf Alu-Unterkonstruktion L²
 ALPHATON® on L² aluminium substructure
 ALPHATON® sur ossature en aluminium (L²)

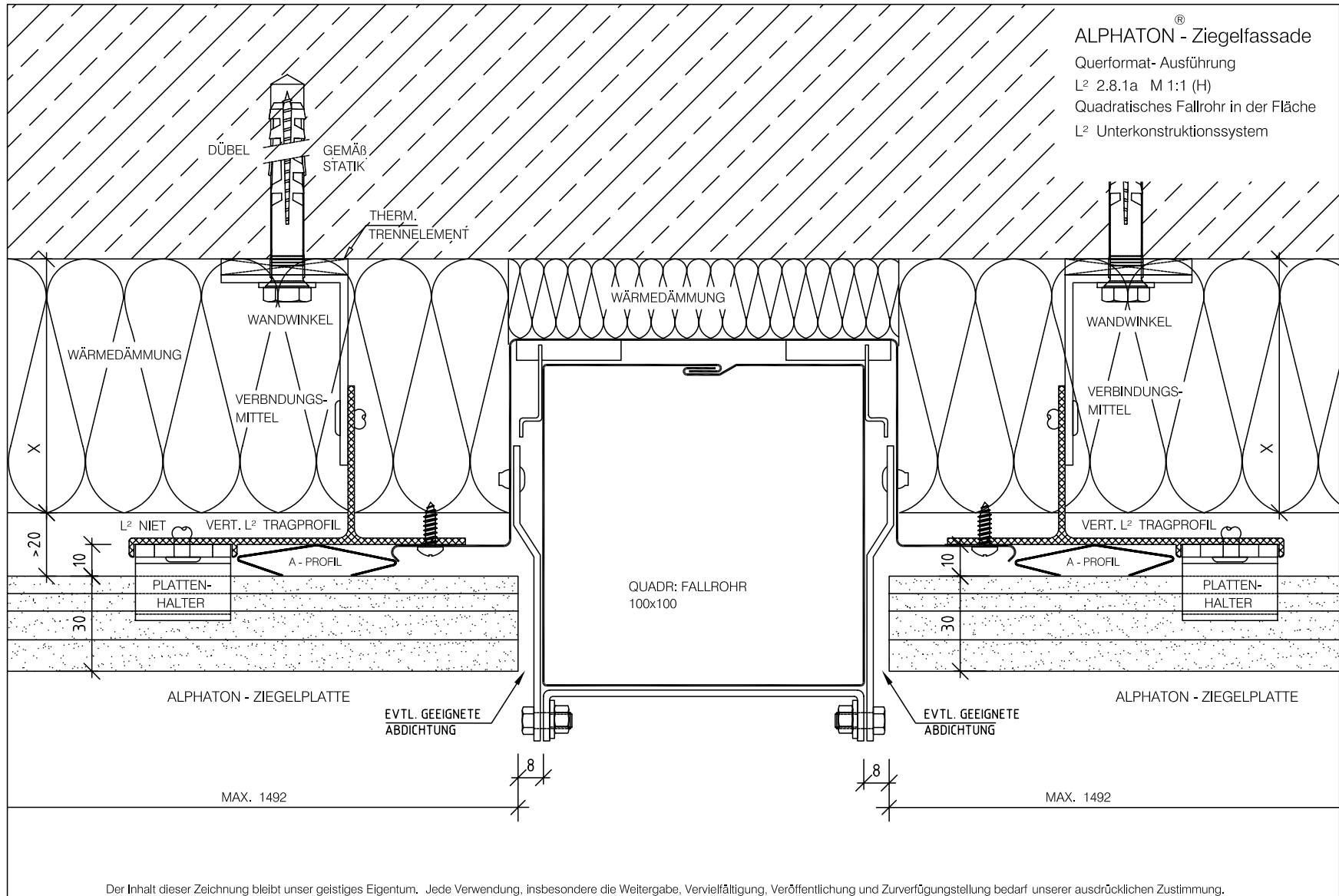

ALPHATON® auf Alu-Unterkonstruktion L²
 ALPHATON® on L² aluminium substructure
 ALPHATON® sur ossature en aluminium (L²)

Fassadenplatten-Fallrohre in der Fläche
 Downpipes integrated in the façade
 Accents verticaux intégrés à la façade

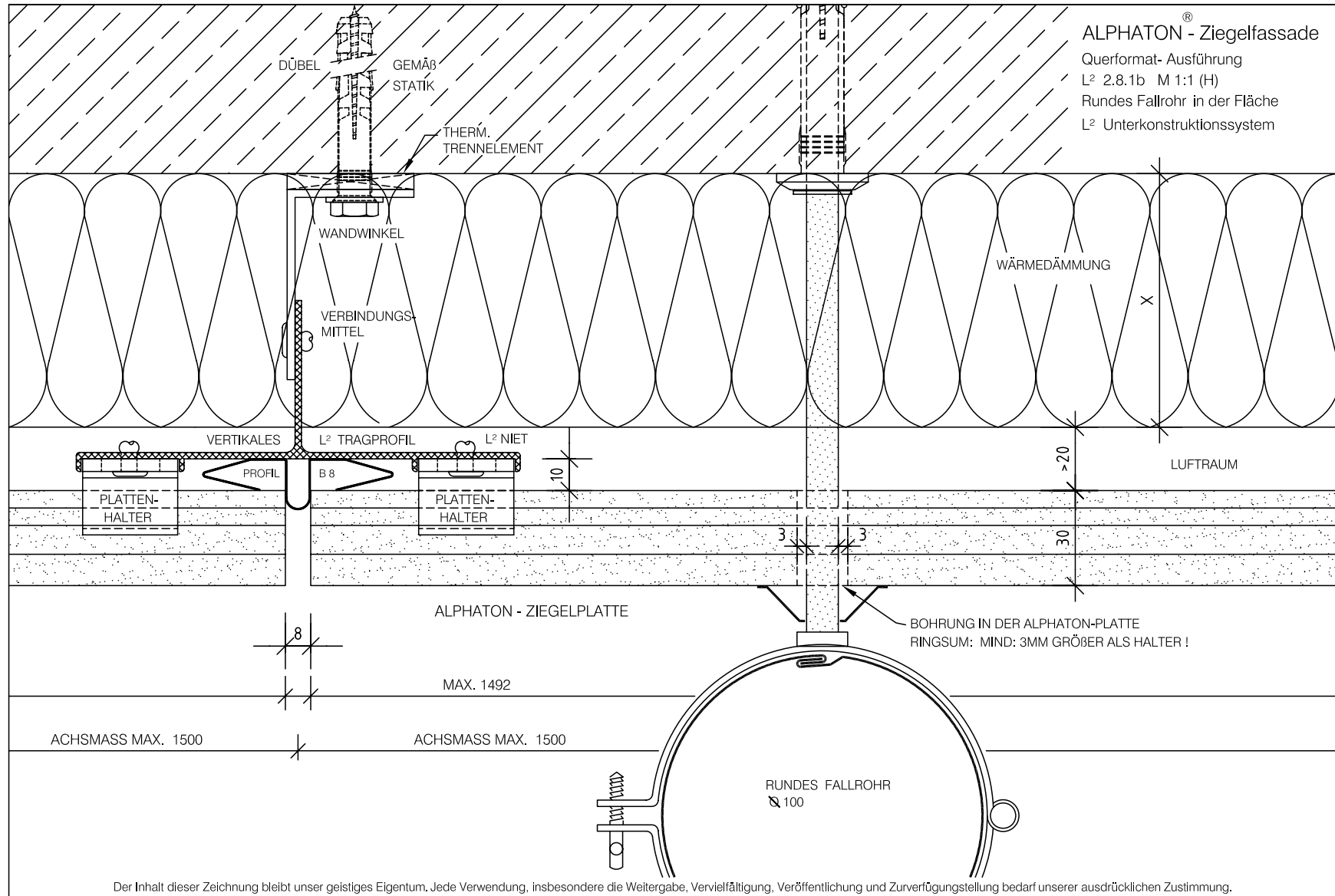



MOEDING

Moeding Keramikfassaden GmbH
Ludwig-Girnghuber-Straße 1
84163 Marklkofen
Germany

Telefon +49 (0) 87 32 / 246 00
Telefax +49 (0) 87 32 / 246 69

E-Mail: info@moeding.de
www.moeding.de